



Transit Supportive Guidelines

For the Chicagoland Region

MARCH 2013

Pulse Addendum Added August 2024

ACKNOWLEDGEMENTS

The Pace Transit Supportive Guidelines for the Chicagoland Region represent the collaborative effort of stakeholders committed to achieving the region's vision for more effective transit service. These stakeholders include elected officials, transportation professionals, municipal staff, regional planning professionals, developers, and others who have a role in creating communities that can successfully support bus transit. Pace appreciates the input provided by the Advisory Committee and Technical Committee throughout this process.

PACE SUBURBAN BUS

Michael Bolton
Ken Grish
George Katsambas
Brandy Kellom
Barb Ladner
Allan Lee
Don McIntyre
Taqhi Mohammed
Phil Parisi
Tom Radak
John Rosengarten
Susan Rushing
Karen Shinnars
Lorraine Snorden
Douglas Sullivan
Mike Teeters
David Tomzik
David Vanderzee
Adrienne Wuellner

ADVISORY COMMITTEE

Chris Aiston, City of St. Charles
Michael Alter, Alter Group
Ivan Baker, Village of Tinley Park
Richard Bascomb, Village of Schaumburg
Lindsay Banks, CMAP
Dan Persky, Active Transportation Alliance
John Greuling, Will Cty Center for Economic Development
Mark Hamilton, Hamilton Partners
Hidetaro Kashima, Westfield Corporation
Ron Lunt, Hamilton Partners
Carol Moore, Village of Riverdale
Stephen Park, Alter Group
Edward Sitar, ComEd
Jeannine Smith, Village of Prairie Grove

TECHNICAL COMMITTEE

Charles Abraham, IDOT
Akheel Ahmed, CTA
John Baczek, IDOT
David Kralik, Metra
Patty Mangano, RTA
Jason Salley, IDOT
Steve Travia, IDOT
Rocco Zuccherro, Illinois Tollway

CONSULTANT TEAM

Houseal Lavigne Associates

John Houseal
Devin Lavigne
Doug Hammel
Nikolas Davis
Ira Mabel
Andrew Broderick

With Assistance Provided By:

Kimley-Horn Associates

Frederick Schwartz, P.E.
IL License #: 062.061476

Altamanu

a5, Inc.

QUICK REFERENCES

This document includes some guidelines and standards that are referenced or adapted from other industry standards or requirements. This page identifies all the resources you, the reader, may need to reference in order to fully implement the Transit Supportive Guidelines for the Chicagoland Region .

PACE STAFF CONTACT

Where you see this icon , it indicates that you may need to contact Pace's Transportation Engineer, the person primarily responsible for administering the Guidelines, for more information about a specific topic or issue. The Transportation Engineer's contact information is:

Senior Transit ITS Engineer

Dep't. of Planning Services
550 W. Algonquin Road
Arlington Heights, IL 60005-4412
t: 847.228.4287
f: 847.228.2330
e: Transportation.Engineer@pacebus.com

TECHNICAL APPENDIX

Where you see this icon , more detailed drawings are provided in the technical appendix for reference by designers and engineers.

MARCH 2013

EXTERNAL REFERENCES

Where you see this icon , it indicates that the following references include more detailed information or specifications related to the standards included in this document. The references should be considered the governing standards for any matter of design implementation. Where the Transit Supportive Guidelines for the Chicagoland Region conflict with these reference materials, the standards identified in the reference materials should be used. It should also be noted that documents referenced below may have been updated since the drafting of these Guidelines. Readers should verify that the most recent external standards are used in design and engineering.

-  American Association of State Highway and Transportation Officials (AASHTO), Guide for the Development of Bicycle Facilities, 4th Edition, 2012.
-  Federal Highway Administration (FHWA), Manual on Uniform Control Devices (MUTCD), 2009.
<<http://mutcd.fhwa.dot.gov>>
-  Illinois Department of Transportation (IDOT), Bureau of Local Roads and Streets Manual, Division of Highways, 2005.
<<http://www.dot.il.gov/blr/manuals/blrmanual.html>>
-  Illinois Department of Transportation (IDOT), Bureau of Design & Environment Manual, Division of Highways, 2010.
<<http://dot.state.il.us/desenv/bdmanual.html>>
-  United States Access Board, ADA Accessibility Guidelines for Transportation Facilities (ADAAG), 2006.
<<http://www.access-board.gov/ada-aba/ada-standards-dot.cfm>>
-  Institute of Transportation Engineers (ITE), Context Sensitive Solutions in Designing Major Urban Thoroughfares for Walkable Communities, 2005
<<http://www.ite.org>>
-  Regional Transportation Authority (RTA), Access and Parking Strategies for Transit-Oriented Development, 2011
<<http://www.rtachicago.com/initiatives/land-use-transit-oriented-development.html>>

Table of Contents



CONTENTS

PREFACE ON ACCESSIBILITY	VII
/1 INTRODUCTION	1
/2 COMPONENTS OF THE TRANSIT TRIP	15
/3 DESIGN GUIDELINES CONTEXT	23
/4 GUIDELINES FOR PACE INFRASTRUCTURE & FACILITIES	43
/5 GUIDELINES FOR THE PUBLIC REALM	85
/6 GUIDELINES FOR THE PRIVATE REALM	109
/7 APPENDIX & PULSE ADDENDUM (2024)	135

Preface on Accessibility

Pace is committed to providing Chicagoland with the highest possible quality of suburban bus transit service. Our service area includes a wide variety of built environments and rider needs. These Transit Supportive Guidelines set forth principles intended to remove barriers to transit use and make bus mobility a viable and convenient alternative. Throughout the Guidelines, accessibility and mobility for people with disabilities is addressed. In several instances, specific documents or regulations are referenced that guide compliance with the Americans with Disabilities Act (ADA) requirements. However, mobility for people with disabilities should permeate all aspects of design in both the private and public realms. All users of this document – designers and engineers, elected officials, transportation planners, property owners, etc. – should strive to create a transit environment that is fully accessible for all potential transit riders. This will enhance the quality of life for Chicagoland residents and foster a more successful transit service on behalf of Pace.



Introduction

To have access to effective public transit, every step of the user's trip must be accessible, efficient, safe, and comfortable. Whether or not one has transportation alternatives, transit is a critical component to quality of life. The transit system must eliminate barriers – real or perceived – in order to make it a viable or preferred alternative. That system, from your front door, to the bus, and to your destination, is the subject of these guidelines. The goal of the Transit Supportive Guidelines for the Chicagoland Region is to foster reliable, efficient, convenient, and accessible transit in communities throughout the Chicago region that are served by Pace Suburban Bus Transit. The Guidelines are designed to be easily understood and referenced by a number of audiences who may have a role in helping to create transit-supportive environments throughout Chicagoland.

WHY SHOULD WE CREATE TRANSIT SUPPORTIVE PLACES?	2
IS TRANSIT SUPPORTIVE DEVELOPMENT ECONOMICALLY VIABLE?	3
WHAT DO TRANSIT SUPPORTIVE PLACES LOOK LIKE?	4

WHY SHOULD WE CREATE TRANSIT SUPPORTIVE PLACES?

Effective transit can make a place more livable, more accessible, more sustainable, and greatly enhance local overall quality of life. Transit services and transit supportive development can provide a wide range of benefits across many sectors of a community. It is not simply the transit provider and rider who benefit; but rather, it is the municipalities, the development community, the non-transit riders, and others that can gain economic, environmental and quality of life benefits.

THE RIDER

- Lower cost of transportation compared to regular automobile use
- Enhanced access to local goods and services, jobs, and regional destinations
- Greater mobility for citizens with disabilities
- Greater passive exercise and lower rate of obesity and related illness
- Easier and safer access to local and regional transit services

SOCIETY

- Fewer environmental impacts than private automobile use
- Greater opportunities for housing choices that allow residents to age within their community
- Enhanced local and regional character
- Reduced congestion on non-transit systems

MUNICIPALITIES AND AGENCIES

- More efficient infrastructure systems and maintenance
- Enhanced local services in more concentrated areas

DEVELOPMENT COMMUNITY

- Greater utilization of available land
- Broader market diversity and feasibility

TRANSIT SERVICE PROVIDER

- Greater integration of facilities into development context
- More predictable ridership volume and behavior
- Enhanced local access to/from transit service
- Safer operations with fewer accidents

IS TRANSIT SUPPORTIVE DEVELOPMENT ECONOMICALLY VIABLE?

Yes! In fact, transit supportive development provides financial benefits for almost everyone. From those who develop transit supportive places, to those who provide or use transit services, transit supportive communities have the potential to enhance community and personal wealth. This page highlights how various groups can realize economic benefits from transit supportive development.

PERSONAL FINANCE

- The average Chicagoan could save \$11,588 per year by switching from driving to public transit. (source: APTA Transit Savings Report, 2012)
- Transit-supportive development places more jobs in areas with greater access.

COMMUNITY QUALITY OF LIFE

- Transit use reduces dependency on limited resources related to private automotive use.
- Fewer environmental impacts are created as development and activities are concentrated in appropriate locations.
- Human capital is maximized as fewer hours are spent in traffic congestion that limits productivity.

MUNICIPAL AND AGENCY MANAGEMENT

- Communities maintain and develop more efficient roadway systems with fewer lane miles when transit replaces personal vehicle use.
- Service providers can access more customers in a smaller geographic area.
- Transit-supportive development results in shorter response times for emergency services.

TRANSIT OPERATIONS AND MANAGEMENT









- Transit-supportive development places more riders closer to transit increasing ridership and decreasing the cost per ride.
- Concentrated and defined activity centers make ridership patterns more predictable, reducing the likelihood of inefficient service concepts.
- Local development provides the opportunity for integrated transit facilities and infrastructure.

DEVELOPMENT FEASIBILITY

- Transit use replaces automobile use and storage, thereby allowing parking areas to be more effectively used for development.
- Mixed-use development mitigates developer risk by diversifying the uses that balance demand as market dynamics change.
- Mixed-use development can accommodate a variety of uses and helps sustain occupancy as market demand evolves.

WHAT DO TRANSIT SUPPORTIVE PLACES LOOK LIKE?

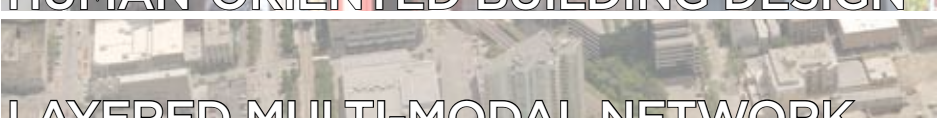
Transit supportive places do not all look the same and can in fact be represented by a wide variety of community types. Communities throughout the Chicago region are made up of many different types of neighborhoods, corridors, and commercial centers. In that regard, it is not suggested that all places be required to look and function in the same way to create transit supportive communities. However, there are some fundamental characteristics of community development and site design that increase the likelihood that an area will support access to and the operation of transit. This section identifies and describes:

 APPROPRIATE DEVELOPMENT INTENSITY	5
 WELL-CONNECTED STREET GRID	6
 COMPREHENSIVE PEDESTRIAN AND BICYCLE INFRASTRUCTURE	7
 COMFORTABLE AMENITIES IN THE PUBLIC REALM	8
 STREETS DESIGNED FOR VEHICLES AND PEDESTRIANS	9
 MIX OF LAND USES	10
 HUMAN-ORIENTED BUILDING DESIGN	11
 LAYERED MULTI-MODAL NETWORK	12
 COMFORTABLE TRANSIT FACILITIES AND AMENITIES	13



WHAT DO TRANSIT SUPPORTIVE PLACES LOOK LIKE?

APPROPRIATE DEVELOPMENT INTENSITY

Appropriate development intensity that supports local businesses and provides activity centers that can be easily and predictably served by transit.

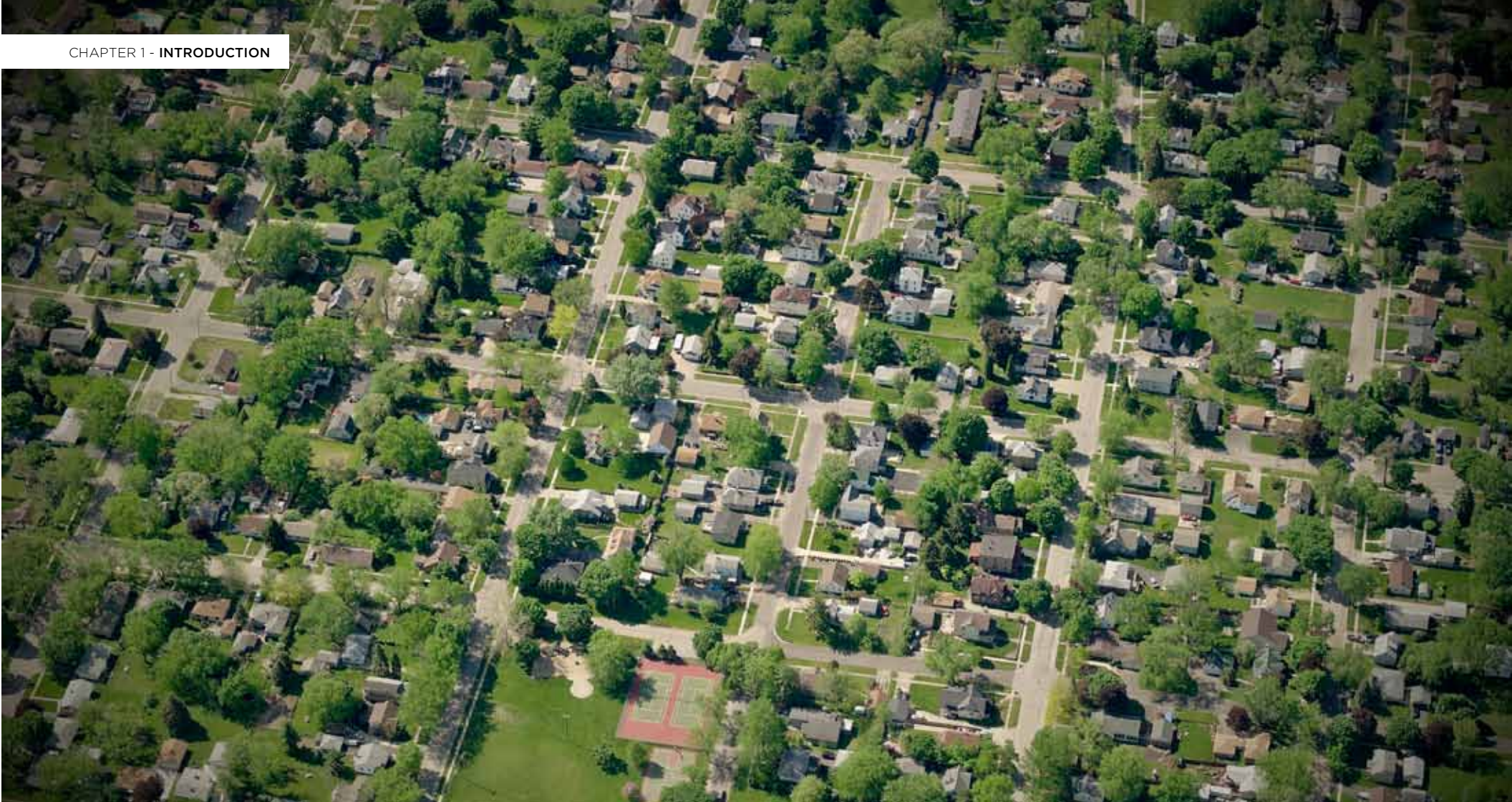

WHAT DO TRANSIT SUPPORTIVE PLACES LOOK LIKE?

WELL-CONNECTED STREET GRID

A **well-connected street grid** providing multiple walking paths and connectivity between several different parts of the community.



WHAT DO TRANSIT SUPPORTIVE PLACES LOOK LIKE?

COMPREHENSIVE PEDESTRIAN AND BICYCLE INFRASTRUCTURE

A **comprehensive pedestrian and bicycle infrastructure** that ensures safe and direct access between transportation facilities and private development.

MARCH 2013



WHAT DO TRANSIT SUPPORTIVE PLACES LOOK LIKE?

COMFORTABLE AMENITIES IN THE PUBLIC REALM

Comfortable amenities in the public realm that foster an active street environment for walking, enjoying local uses and waiting for transit service.



WHAT DO TRANSIT SUPPORTIVE PLACES LOOK LIKE?

STREETS DESIGNED FOR VEHICLES AND PEDESTRIANS

Streets designed for vehicles and pedestrians that isolate transportation modes when appropriate and manage conflict points between pedestrians and motorists.



WHAT DO TRANSIT SUPPORTIVE PLACES LOOK LIKE?

MIX OF LAND USES

A **mix of land uses** that results in high levels of pedestrian activity throughout different portions of the day and week.



WHAT DO TRANSIT SUPPORTIVE PLACES LOOK LIKE?

HUMAN-ORIENTED BUILDING DESIGN

A **human-oriented building design** including facade articulation, awnings, pedestrian lighting, and signage, etc., that reinforces local identity, creates engaging building facades and uses, and results in a comfortable sidewalk environment for pedestrians.

MARCH 2013



WHAT DO TRANSIT SUPPORTIVE PLACES LOOK LIKE?

LAYERED MULTI-MODAL NETWORK

A **layered multi-modal network** that balances the needs of motorists, pedestrians, bicyclists and transit riders.



WHAT DO TRANSIT SUPPORTIVE PLACES LOOK LIKE?

COMFORTABLE TRANSIT FACILITIES AND AMENITIES

Comfortable transit facilities and amenities that appropriately manage the interface between private development and transit service, especially in inclement weather.

Chapter 2

Components of the Transit Trip



A transit trip involves more than just the bus stop or the bus itself. It encompasses all of the activities and movements required to go from one location to another – from a trip’s point of origin to the final destination. From walking down the street to riding the bus, the complete transit trip and all of its related components are addressed in these design guidelines.

THE RIDER	17
THE DEVELOPMENT LOT	18
THE PUBLIC WALK	19
THE TRANSIT STOP	20
THE TRANSIT VEHICLE & INFRASTRUCTURE	21

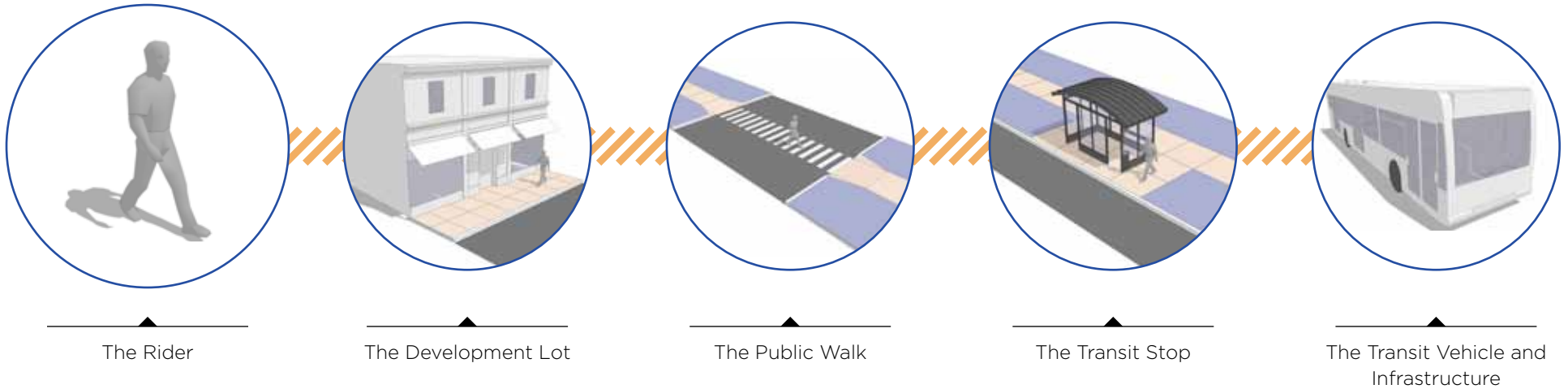

THE COMPONENTS OF THE TRANSIT TRIP

This page identifies the components of the complete transit trip and establishes the structure for the guidelines found in subsequent sections of this document.

The one common element in each component is the rider. It is imperative that all trip components put the rider first in terms of design and implementation of the transit environment. The complete transit trip includes the following components:

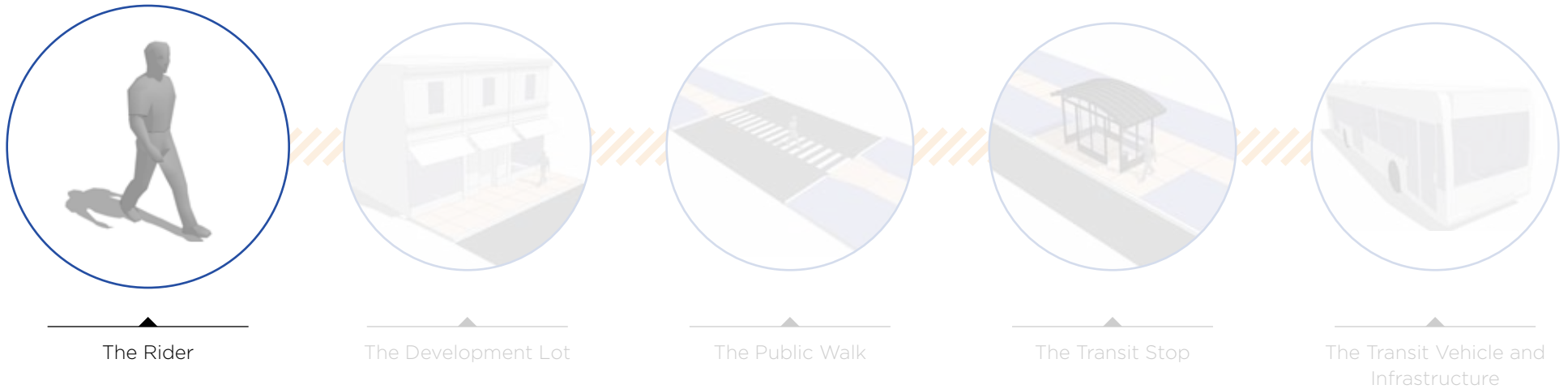

THE RIDER

All aspects of the transit trip should be designed around the rider. When the scale and behavior of people is considered, various aspects of the built environment - from building scale to the amount of time it takes to cross a street - can be configured to remove the barriers that inhibit transit use. Functional aspects of the trip, such as the need for reliable information, must also be considered from the perspective of the rider.



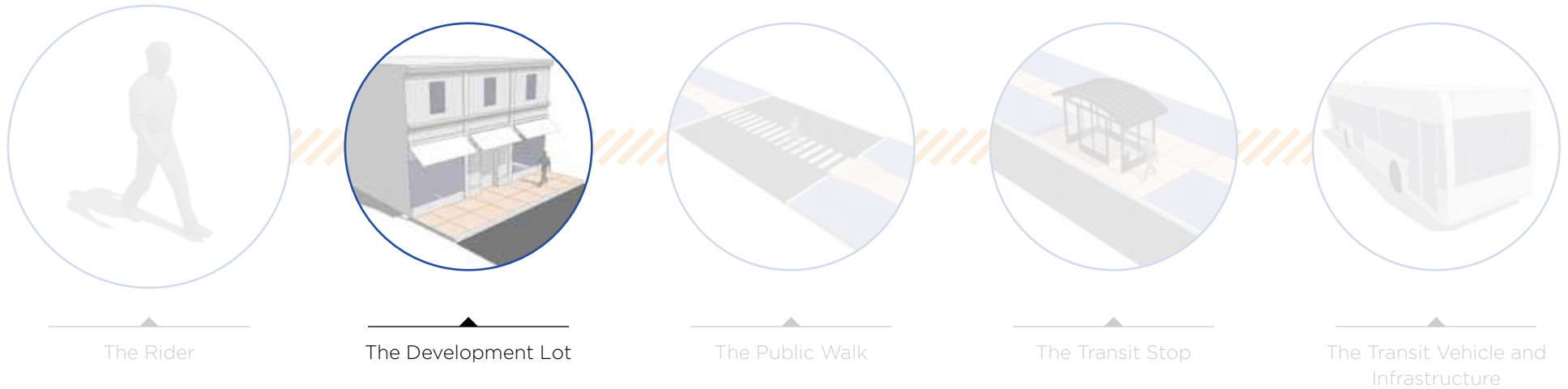

THE DEVELOPMENT LOT

The development lot represents both the origin and destination of the transit trip. For the purposes of these design guidelines, the “development lot” may include designated parcels (i.e. housing, commercial services, libraries, etc.) or public spaces that may serve as destinations (i.e. public open spaces, street environments, campuses, etc.) How the development lot is designed is most frequently dictated by zoning and subdivision regulations.



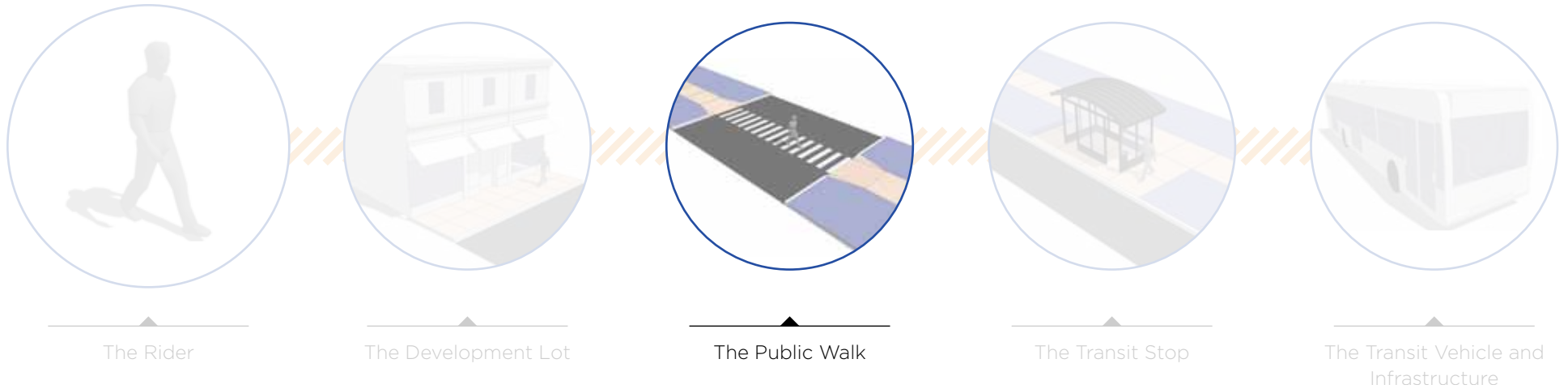

THE PUBLIC WALK

The public walk is the critical link between the development lot and transit stop. Elements of the public walk include sidewalks, crosswalks, components of accessibility, and landscaping and buffering. Collectively, these elements influence the composition of the “last mile” (or sometimes the “first mile”) that often determines the success of transit service.





The Rider



The Development Lot

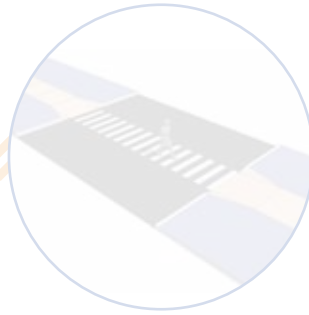

The Public Walk

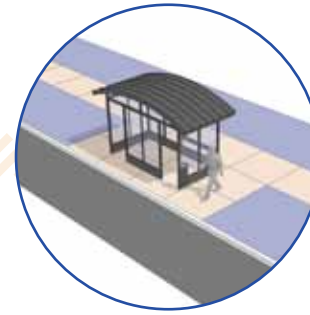

The Transit Stop



The Transit Vehicle and Infrastructure

THE TRANSIT STOP

The transit stop is the “front door” of the transit service. Stops come in many shapes and sizes, from stand-alone stops with simple shelters to larger transfer facilities integrated into private development. Whatever the size, transit stops must meet basic rider needs in terms of safety, comfort and information.



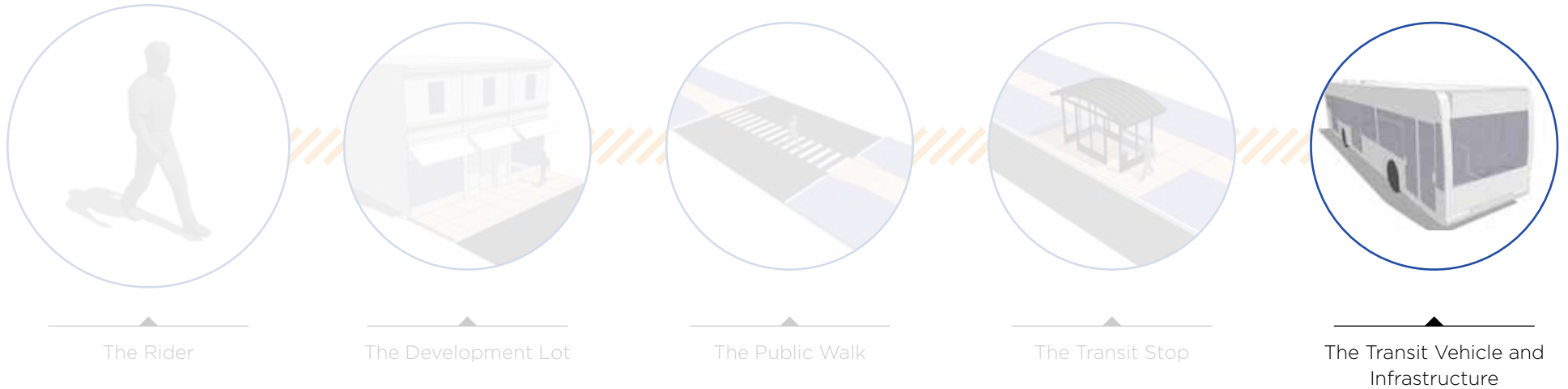

THE TRANSIT VEHICLE & INFRASTRUCTURE

The transit vehicle and the infrastructure on which it operates represent the actual “transit service,” or the function of providing a means of movement other than personal vehicles or walking. The vehicle is often what defines people’s perceptions of transit - “Is it clean and comfortable?”; “Is the driver courteous and professional?” The infrastructure is the space and facilities on which the transit vehicle operates. This may include dedicated lanes and turn out areas, signalization technologies, roadway dimensions, etc.



Chapter 3

How Do Design Guidelines Fit Within the Regional Context?

Chicagoland is a mosaic of different communities all with different physical, environmental, regulatory, aspirational, and policy conditions. The Design Guidelines must be direct in their recommendations, yet broadly applicable to the wide spectrum of communities that exist throughout the region. The Design Guidelines must balance existing conditions with the region's vision for more transit-friendly development and the on-going evolution of Pace bus service. Finally, the Design Guidelines must be easily understood and implemented, serving to guide a wide range of diverse users and stakeholders.

WHAT KINDS OF PLACES DOES PACE SERVE WITH BUS TRANSIT?	24
WHAT IS THE VISION FOR REGIONAL GROWTH AND DEVELOPMENT?	34
HOW WILL TRANSIT CONTINUE TO MEET RIDERS' NEEDS?	36
WHAT ARE THE DESIGN GUIDELINES?	38
WHO WILL USE THE GUIDELINES?	39
HOW WILL THE GUIDELINES BE IMPLEMENTED?	40

WHAT KINDS OF PLACES DOES PACE SERVE WITH BUS TRANSIT?

Riders access Pace facilities and vehicles through a variety of places. Factors that differentiate place types include land use and development intensity, building scale, site configuration, presence of other transit modes, the dimensions and design of elements in the public realm, and the patterns of vehicular traffic on roadways. Understanding these place types helps to establish design guidelines that can be effectively utilized by many different communities. These factors have a tremendous influence on transit service needs and opportunities.

	25
TRADITIONAL DOWNTOWN	
	26
URBAN AND SUBURBAN NEIGHBORHOODS	
	27
TRADITIONAL CORRIDOR	
	28
SUBURBAN CORRIDOR	
	29
BUS/MULTI-MODAL TRANSIT CENTER	
	30
COMMUTER RAIL STATION	
	31
LOCAL RETAIL CENTER	
	32
REGIONAL RETAIL CENTER	
	33
INDUSTRIAL OR OFFICE CAMPUS	

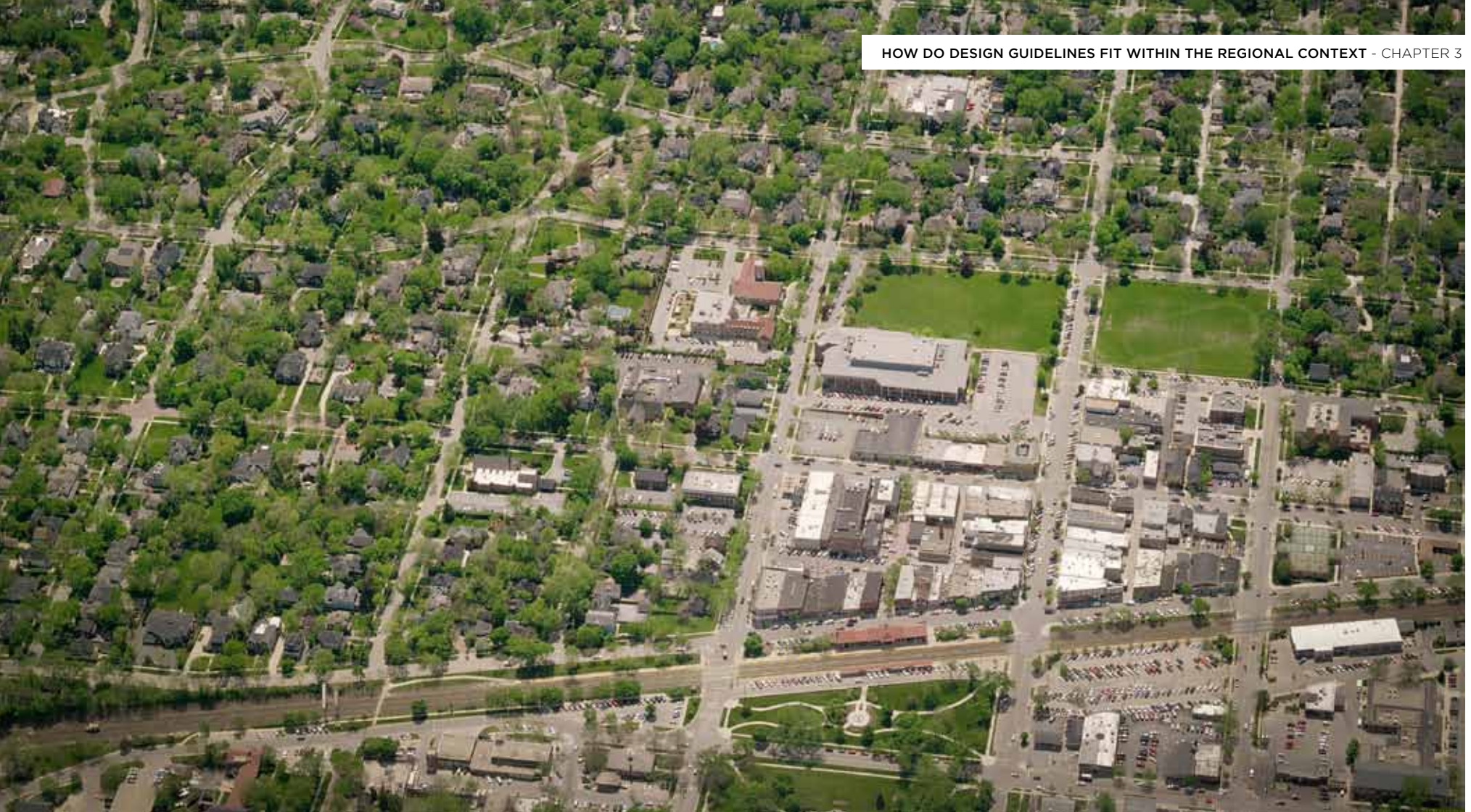

WHAT KINDS OF PLACES DOES
PACE SERVE WITH BUS TRANSIT?

TRADITIONAL DOWNTOWN

Traditional downtowns that typically include zero-setback development, relatively narrow travel lanes, on-street parking, a strong orientation towards pedestrian mobility, and central destinations.



**WHAT KINDS OF PLACES DOES
PACE SERVE WITH BUS TRANSIT?**

URBAN AND SUBURBAN NEIGHBORHOODS

Urban and suburban neighborhoods that include a variety of housing densities, block sizes and patterns, and level of access to peripheral connector and arterial streets.

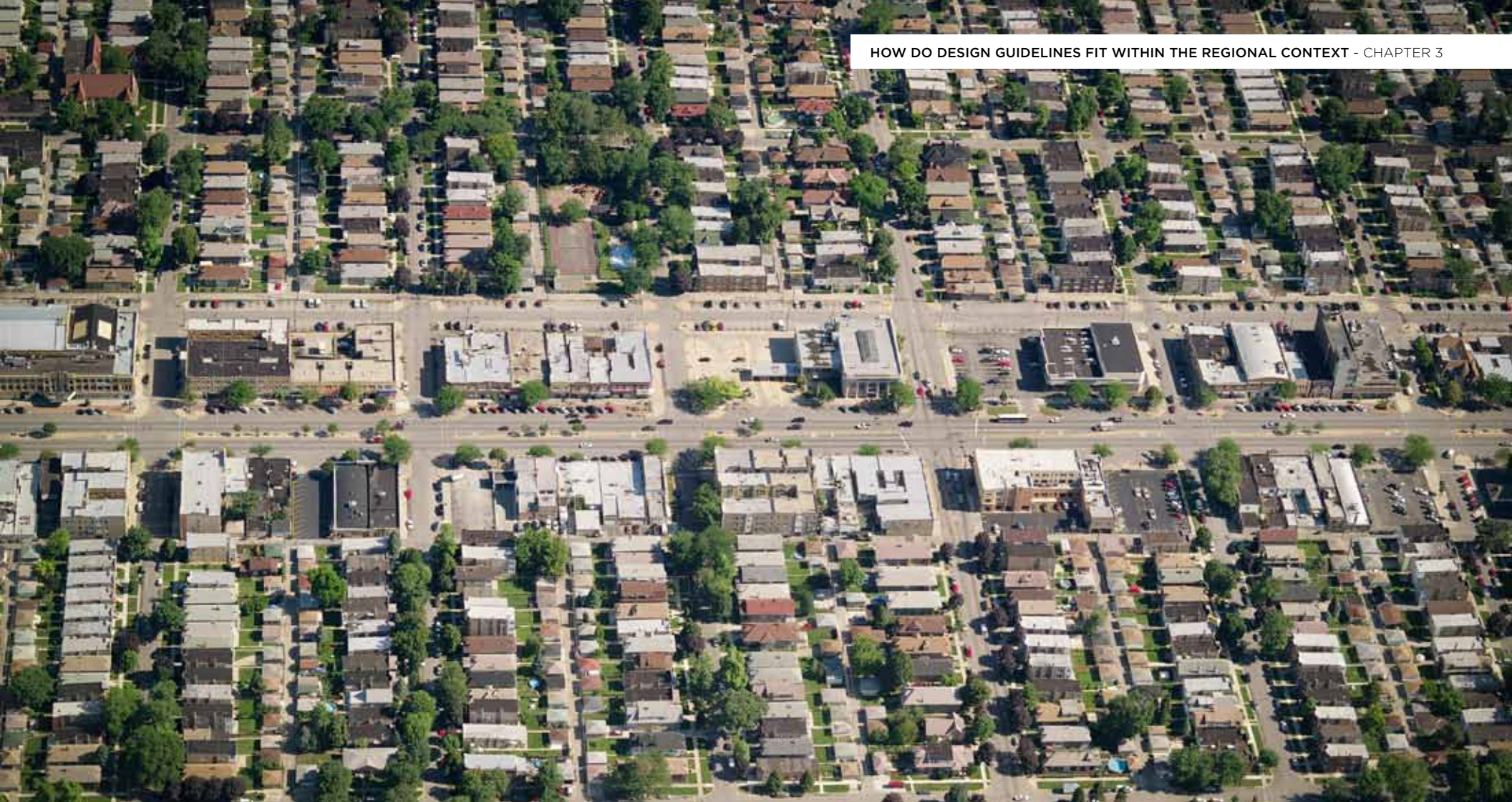

WHAT KINDS OF PLACES DOES
PACE SERVE WITH BUS TRANSIT?

TRADITIONAL CORRIDOR

Traditional corridors that frequently provide moderate travel speeds, a balanced focus on vehicular and pedestrian mobility, and a broad mix of commercial and residential uses.

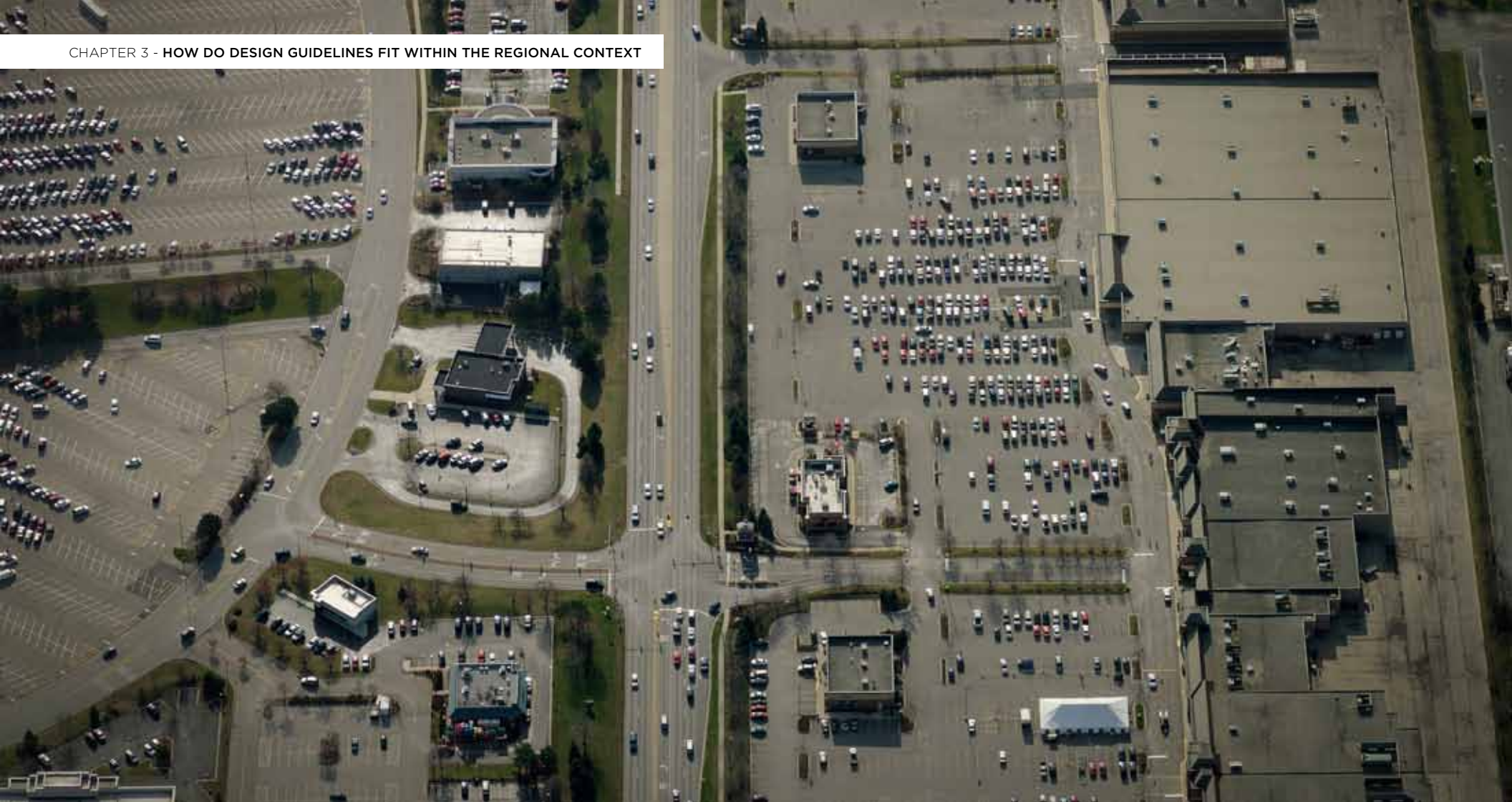

WHAT KINDS OF PLACES DOES
PACE SERVE WITH BUS TRANSIT?

SUBURBAN CORRIDOR

Suburban corridors that typically foster regional mobility, focus primarily on vehicular mobility, and host a variety of commercial uses of various sizes and complexities.

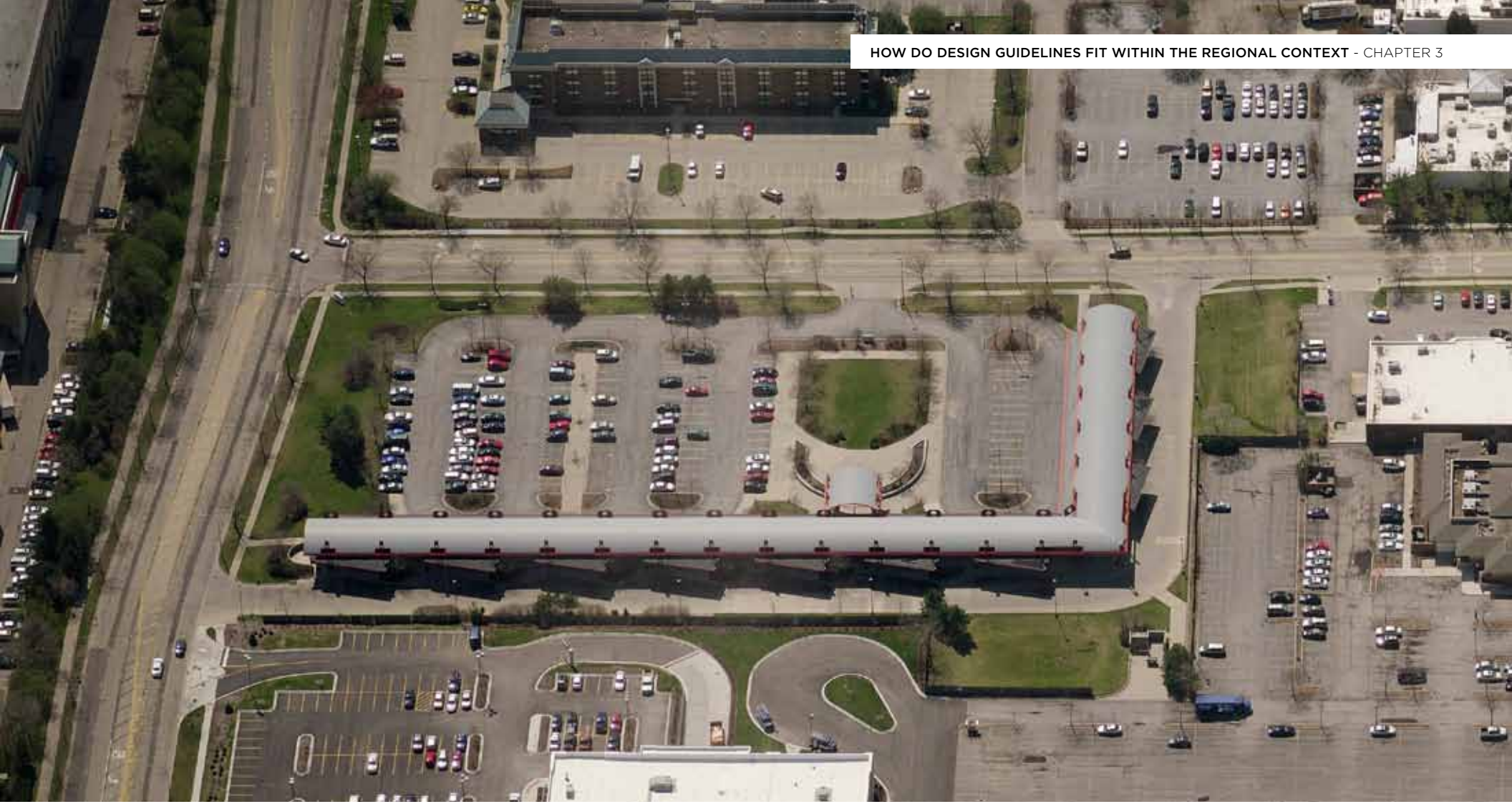

WHAT KINDS OF PLACES DOES
PACE SERVE WITH BUS TRANSIT?

BUS/MULTI-MODAL TRANSIT CENTERS

Bus/multi-modal transit centers that provide transfer opportunities for riders, offer stopover facilities for drivers, and may be integrated into other developments or uses.



WHAT KINDS OF PLACES DOES
PACE SERVE WITH BUS TRANSIT?

COMMUTER RAIL STATION

Commuter rail stations that provide for direct transfers between bus and commuter rail service, and may be integrated into other developments or place types.



WHAT KINDS OF PLACES DOES
PACE SERVE WITH BUS TRANSIT?

LOCAL RETAIL CENTER

Local retail centers that provide central destinations along corridors, host local commercial uses, and focus primarily on vehicular accessibility.



WHAT KINDS OF PLACES DOES
PACE SERVE WITH BUS TRANSIT?

REGIONAL RETAIL CENTER

Regional retail centers that occupy large tracts of land, host regional and local commercial destinations, and foster the possibility of on-site transit facilities.



WHAT KINDS OF PLACES DOES
PACE SERVE WITH BUS TRANSIT?

INDUSTRIAL OR OFFICE CAMPUS

Industrial or office campuses that include significant employment centers, minimal retail or residential uses, and could possibly accommodate on-site transit or shuttle operations.

WHAT IS THE VISION FOR REGIONAL GROWTH AND DEVELOPMENT?

The Chicago region is an ever evolving environment. Undeveloped areas are seeing new investment, and built areas are being redefined through infill development and revitalization efforts. The Chicago Metropolitan Agency for Planning (CMAP) adopted a regional plan entitled GoTo 2040 that articulates a vision for the region which includes community livability, resource conservation, walkability, and transit, among other things.

"Achieve greater livability through land use and housing."

"Manage and conserve water and energy resources. Emphasis on compact, mixed use, walkable development served by transit will improve the region's energy efficiency..."

"Increase commitment to public transit. Transit works best when it is supported by small-scale infrastructure improvements... and by land use planning."



WHAT IS THE LOCAL COMMUNITY VISION?

The Chicago region is an ever evolving environment. Undeveloped areas are seeing new investment, and built areas are being redefined through infill development and revitalization efforts. Though local visions vary from one community to another, many address a series of development characteristics that directly or indirectly accommodate and support transit.

1. Snapshot of existing conditions and characteristics
2. Articulation of realistic expectations
3. Description of a desired outcome or vision
4. Goals and objectives to attain the vision
5. Area- or topic-specific recommendations
6. Action program to attain the vision over time

Transportation Plan
The Transportation Plan identifies recommended improvements to enhance access and circulation in the Village.

Transportation Legend

- Mean Average Daily Traffic Count
- Interstate
- Principal Arterial
- Minor Arterial
- Collector Street
- Local Streets
- Speed Improvement
- Traffic Signals
- Proposed Traffic
- Potential Wadway
- Parking Demand
- Transit Lane
- Parks & Open Space
- Village Limits
- North Branch
- Railroad

Project Initiation Workshop
A major mission of the Village of Niles is to ensure that the Village of Niles Comprehensive Plan is implemented in a way that meets the needs of the community. The Village of Niles is currently in the process of updating the Village of Niles Comprehensive Plan. The Village of Niles is currently in the process of updating the Village of Niles Comprehensive Plan. The Village of Niles is currently in the process of updating the Village of Niles Comprehensive Plan.

Workshop Questionnaire

1. Identify five (5) areas of concern within the Village of Niles.
2. List, in order of importance, the three (3) most important areas of concern within the Village of Niles.
3. Identify three (3) specific projects or actions that you would like to see implemented within the Village of Niles.
4. What are the greatest assets, strengths and advantages of the Village of Niles?

Implementation Action Matrix

Subject	Recommended Action	Priority	Responsible Party
Land Use and Development	Review and update the Village of Niles Comprehensive Plan to ensure compatibility with the Village of Niles Comprehensive Plan.	High	Village of Niles
Public Safety	Review and update the Village of Niles Comprehensive Plan to ensure compatibility with the Village of Niles Comprehensive Plan.	High	Village of Niles
Community Center	Review and update the Village of Niles Comprehensive Plan to ensure compatibility with the Village of Niles Comprehensive Plan.	High	Village of Niles
Public Works	Review and update the Village of Niles Comprehensive Plan to ensure compatibility with the Village of Niles Comprehensive Plan.	High	Village of Niles
Parks, Trails, Open Space	Review and update the Village of Niles Comprehensive Plan to ensure compatibility with the Village of Niles Comprehensive Plan.	High	Village of Niles

Implementation Strategy #1

Plan excerpts from the Village of Niles Comprehensive Plan

HOW WILL TRANSIT CONTINUE TO MEET RIDERS' NEEDS?

As regional growth expands in an already complex system of communities in Chicagoland, regional transit must evolve to better serve established areas as well as provide new transit options for areas currently not served by transit. Pace is constantly coordinating with the Regional Transportation Authority (RTA), Metra Commuter Rail, Chicago Transit Authority (CTA), and independent transit providers to create the most effective bus transit system possible. The ongoing challenge is providing both efficient local transit service as well as regional connections between communities throughout Chicagoland. Pace's Vision 2020 Plan sets a course for an innovative multi-layered service model that complements community-based support services. Pace's Vision 2020 and Arterial Rapid Transit (ART) Initiative identify a variety of layered types of services that collectively provide balanced regional and local mobility.

TRANSIT COLLABORATION

Pace is committed to using its resources to provide the highest level of bus transit service possible. Where service gaps exist, Pace often collaborates with other transit providers, local municipalities, or stakeholders to share the task of providing effective transit for specific market segments. Vanpools, dial-a-ride, call-n-ride, and local circulator services can be coordinated and funded by different types of service agreements between the entities described above.

SERVICE TYPES

The level of service provided along any corridor or within a given service area depends on a number of factors, including population and employment density, proximity of existing service, transit and vehicle travel times, congestion, typical transit vehicle dwell times, vehicle ownership, household income and regional travel patterns. In other words, no single measure will determine the type of service Pace provides at an individual location.

The graphics on the following page describe the general characteristics of various types of Pace services that may be implemented, either autonomously or in different combinations, to enhance local mobility. The different types of service may require varying degrees of infrastructure investment such as transit signal priority, bus only lanes, or queue jump lanes. Municipalities and developers should contact Pace regarding planned service along specific corridors and within specific service areas.

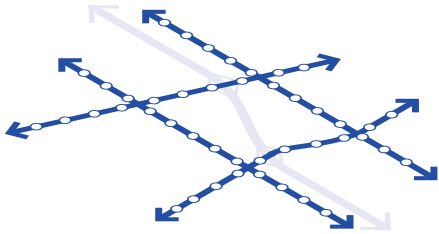

Local/Arterial Bus

This includes Pace's traditional fixed-route service making local stops. Local/Arterial service benefits from direct access to population, employment, and retail densities close to transit stops. Buses make frequent stops, typically every 1/8-mile to 1/4-mile, and provide access to other transit routes, paths, and pedestrian networks.

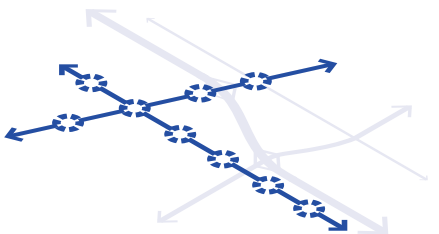

Arterial Rapid Transit (ART)

This includes service on priority transit corridors. ART service is typically used to provide mobility across greater distances than local trips, and stops are located to provide access to local fixed-route service, major activity centers, and other significant ridership nodes. Stops are less frequent, typically every 1/4-mile to 1/2-mile, and include greater infrastructure investment in stops and transit roadways.

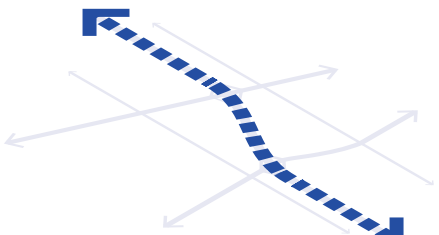

Express Bus Service

This includes routes designed to take advantage of expressways and regional arterials to provide high-speed regional mobility with few stops. These routes are designed to quickly move rider from one portion of the region to another, with limited local stops at park-n-ride facilities or major activity centers. Expressway operations bypass most local or intermediate trips.

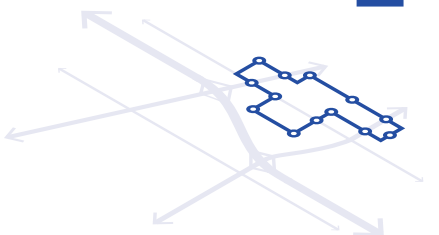

Local Circulator, Call-n-Ride/Dial-a-Ride

This includes local routes that serve specific community destinations and may be subsidized by local entities or municipalities. These routes typically operate on local streets using smaller connector buses to provide local mobility. They typically require little investment in infrastructure, but provide connections to other local or regional transit services. These may include fixed-route circulator buses, or demand-response Call-n-Ride or Dial-a-Ride services that provide door-to-door service through reserved trips.

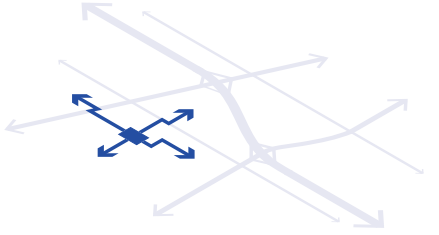

Carpool/Vanpool Shuttle

This includes carpool or vanpool services initiated by local stakeholders and coordinated through Pace. Typically serving a specific destination, such as an office building or corporate center, the carpool or vanpool shuttle provides mobility for a specific market of riders that cannot otherwise be effectively served by traditional transit.

**PACE-OPERATED
REGIONAL FIXED-ROUTE
SERVICES**

**PACE/PRIVATE PARTNER
FLEXIBLE LOCAL SERVICE**

WHAT ARE THE DESIGN GUIDELINES?

The Pace Transit Supportive Guidelines for the Chicagoland Region will serve as a foundation for municipalities, service providers, developers and land owners, and other agencies to assess their own regulations and standards in terms of how well they support transit service and access. The Guidelines themselves are not regulatory. However, they demonstrate development principles and include measurable standards that can be easily integrated into local zoning and subdivision regulations, public works standards, development standards and review procedures, and other policies that shape the built environment.

CHAPTER 4. GUIDELINES FOR PACE OPERATIONS & FACILITIES

- Vehicle, Service & Roadway Characteristics
- Bus Stop Location & Roadway Design
- Off-Street Facilities
- Passenger Waiting Areas
- References

CHAPTER 5. GUIDELINES FOR THE PUBLIC

- Street Network Design
- Creating Safe & Comfortable Sidewalks
- Managing Shared Pedestrian/Vehicular Spaces

CHAPTER 6. GUIDELINES FOR THE PRIVATE REALM

- Transit-Supportive Land Use
- Site Design
- Parking & Access Management
- Building Design
- On-Site Transit Facilities

CHAPTER 7. APPENDIX

- Comprehensive Transit Checklist
- Technical Appendix

WHO WILL USE THE GUIDELINES?

The Design Guidelines have broad applicability. They can be used as a basis for developing policies by municipal departments, as a reference for local interests who advocate for the development of transit supportive communities and a sustainable region, and as a tool for residents to simply understand the intent of community development and its relationship to public transit. However, within this context, the Guidelines have been crafted to respond to a multi-layered set of potential users. The table to the right describes the range of potential users for the design guidelines, as well as potential implementation mechanisms available to help attain implementation of a more transit supportive region.

User Tier	Relevant Parties	Potential Implementation Mechanisms
<p>Primary users are those who are most directly responsible for regularly creating and implementing transit and development policy</p>	Pace Municipal planning and zoning staff Planning and zoning commissions Elected officials Public works staff and DOT's Developers Designers & engineers Consultants Tollway operators	Agency planning and design standards Municipal planning and design standards Municipal zoning and subdivision regulatory amendments Municipal development review amendments Monetary or procedural development incentives Private/public partnership practices
<p>Secondary users are those who may have a limited role in creating or implementing policies related to development, infrastructure or services impacting bus transit</p>	RTA CTA Metra Other government agency service providers Secondary review commissions (i.e. Historic Preservation Boards) Regional planning entities (i.e. CMAP) Private infrastructure providers (i.e. railroads) Sub-regional or local support agencies (i.e. Local Economic Development Commission, Council of Governments)	Inter-agency transit service plans Review and approval guidelines for specific local boards and commissions Regional planning and best practices Local best practices for development and design
<p>Tertiary users are those who may reference the Guidelines as an educational or advisory piece in understanding and implementing the goals of transit supportive development</p>	Residents Owners or managers of private properties Advocacy groups Researchers	Local and regional marketing campaigns Targeted advocacy to primary and secondary users Education and outreach to all interested and impacted parties

HOW WILL THE GUIDELINES BE IMPLEMENTED?

The Transit Supportive Guidelines for the Chicagoland Region may be referenced by a broad set of stakeholders, officials, and residents. It is important to recognize how each potential member of the regional audience plays a role in implementing the Guidelines to create a more transit supportive Chicagoland.

Typically, the creation of a transit supportive environment will require coordination among several agencies. This will usually occur during the development review processes administered by municipalities with regulatory purview over a specific development lot. In that light, municipalities should consider how their procedures for review and approval accommodate review by Pace and other impacted agencies. The flow chart to the right shows generally how such agency review might fit into local procedures, recognizing that every municipality has its own set of specific review bodies, development regulations, boards and commissions, and local goals and objectives.

PACE DEVELOPMENT REVIEW ASSISTANCE FOR TRANSIT (DRAFT)

In order to ensure that development proposals contribute to a transit supportive region, Pace offers complementary in-house technical review under its Development Review Assistance For Transit Program. Developers and designers can participate in the program voluntarily, though local municipalities may require Pace review as a part of local development review for projects that meet certain criteria. These reviews are conducted by Pace’s Transportation Engineer and are designed to promote the incorporation of public transportation features in suburban developments. The provision of transit service also is analyzed during this plan review process. Existing Pace service to the development site is reviewed and service needs resulting from the new development plans are analyzed. The following page offers additional information regarding the DRAFT program, and a detailed packet of program information can be obtained by [contacting Pace’s Transportation Engineer](#), or by visiting www.paceguidelines.com.



Why should I participate in the DRAFT program?

Pace's DRAFT program is intended to help coordinate the efforts of private development, municipal services, local infrastructure and bus transit services and facilities. Through the program, developers can work directly with Pace to accommodate characteristics of transit supportive development that enhance the vibrancy of the development and improve access to adjacent communities within the region. As a result, development will be more accessible by a greater number of users, and transit integration can be accommodated with little or no retrofit after build-out.

Participation is encouraged for any project that might in any way impact Pace services and infrastructure, including projects that include on-site Pace facilities, abut corridors served by Pace, or significantly alter the potential for a local ridership market. Development projects can be enhanced by transit service that expands its market reach and enhances access for a broader range of potential users.

How do I participate?

If you have a development project that could impact existing bus services or benefit from better coordination with Pace, please contact the  Pace Transportation Engineer. The Engineer is in charge of administering the DRAFT program and coordinating with other Pace staff as needed to properly assess the impacts of a development project.

What information do I need to provide?

Each project is unique, but generally, participants will be asked to provide design plans similar to what municipalities require for review by zoning, fire and public works staff. The intent of the DRAFT program is not to impose undue burdens on developers and designers, but rather to integrate Pace review in a manner that is as seamless and unobtrusive as possible.

How long does the process take?

The DRAFT process can vary depending on the complexity and scale of the project. However, Pace strives to complete review with the applicant within 3-4 weeks of submittal. Factors that impact the length of the review process include:

- » The scale of the portion of the proposed project that impacts transit facilities and services
- » The nature of existing transit service on and around the proposed project site
- » The planned future service characteristics on and around the proposed project site
- » The relationship between on-site transit facilities and other characteristics of the project
- » The magnitude of impacts the proposed project may have on existing or planned services and facilities (i.e. significant increases in population or traffic)

Chapter 4

Guidelines for Pace Infrastructure & Facilities

It is critical that local development be closely coordinated with Pace to ensure that residents and businesses maximize the benefits offered by transit service. This chapter describes the service types, facilities and infrastructure anticipated by Pace in an effort to foster coordination among transit service providers, municipalities, and other agencies responsible for roadway design and operations.

VEHICLE, SERVICE & ROADWAY CHARACTERISTICS	45
BUS STOP LOCATION & ROADWAY DESIGN	51
OFF-STREET FACILITIES	61
PASSENGER WAITING AREAS	71

Section 4a

Vehicle, Service & Roadway

In order to balance safe and efficient operation of transit with general traffic flow, it is important to consider transit vehicle measurements and operational characteristics when designing roadways, intersections, and transit facilities that will be used by Pace vehicles. Proper design minimizes transit vehicle encroachment into other lanes of traffic, decreases property and vehicle damage, reduces travel times, improves passenger comfort and safety, and helps maintain pavement surfaces.

VEHICLE SPECIFICATIONS **46**

VEHICLE TURNING RADIUS **47**

ROADWAY GEOMETRICS **48**



Transit Rolling Stock
 Transit vehicles vary in size and maneuverability, and local infrastructure should be designed to respond to specific transit operations and rolling stock characteristics.

VEHICLE SPECIFICATIONS

Pace offers a variety of both fixed and variable-routes service, using a wide range of vehicle types. For flexible route services, such as Dial-a-Ride, Paratransit, and Call-n-Ride services, Pace operates a fleet of vehicles ranging in size from vans to 30-foot Paratransit buses.

All fixed-route services use buses that are 30-feet or longer, and vehicle size is directly related to the type of service provided.

Pace recommends that, whenever possible, shoulder widths, pavement design, curbs, building overhangs, clearance areas, vehicle stop area dimensions, and turning radii on all bus routes should be designed to accommodate the specific type of vehicle serving the route, or that may serve the route in the future. Local entities should consult with Pace when designing infrastructure to determine the anticipated future service and vehicle types to be used in a given location.

The table to the right describes the assumed dimensions of various types of Pace vehicles.

Dimension	Connector	Local Bus	Express Bus/ART
Length	30'-32'	40.0'	45'
Length with bumpers	30.5	40.7'	45.6'
Width	8.5'	8.5'	8.5'
Width with mirrors	10.0'	10.0'	10.0'
Height	10.5'	10.5'	10.5'
Wheelbase	13.3'	25.0'	27.7'
Front Overhang	-	7.0'	7.7'
Rear Overhang	-	8.0'	10.25'
Ground Clearance	-	11"	-
Vertical Clearance	12'	12'	12'

The dimensions provided above are derived from current manufacturer specifications or TCRP Report 19. The dimensions of ART/Express vehicles will be dependent upon the vehicle type ultimately determined by Pace. Pace should be contacted for any other vehicle dimensions or specifications not provided in this table.

VEHICLE TURNING RADIUS

To accommodate Local, Express and ART buses, Pace recommends designing for a minimum 50-foot outside turning clearance at all locations where Pace vehicles turn. The 50-foot design radius meets Pace's vehicle turning needs under ideal operating conditions. Minimum clearances are generally sufficient for ideal conditions at speeds of less than 10 miles per hour. Other turning radii may apply based on different intended travel speeds, vehicle dimensions, turning characteristics, levels of traffic congestion, sight lines, and snow accumulation. Manufacturer specifications, transportation engineering standards, and/or the Pace Transportation Engineer should be consulted for more specific information.

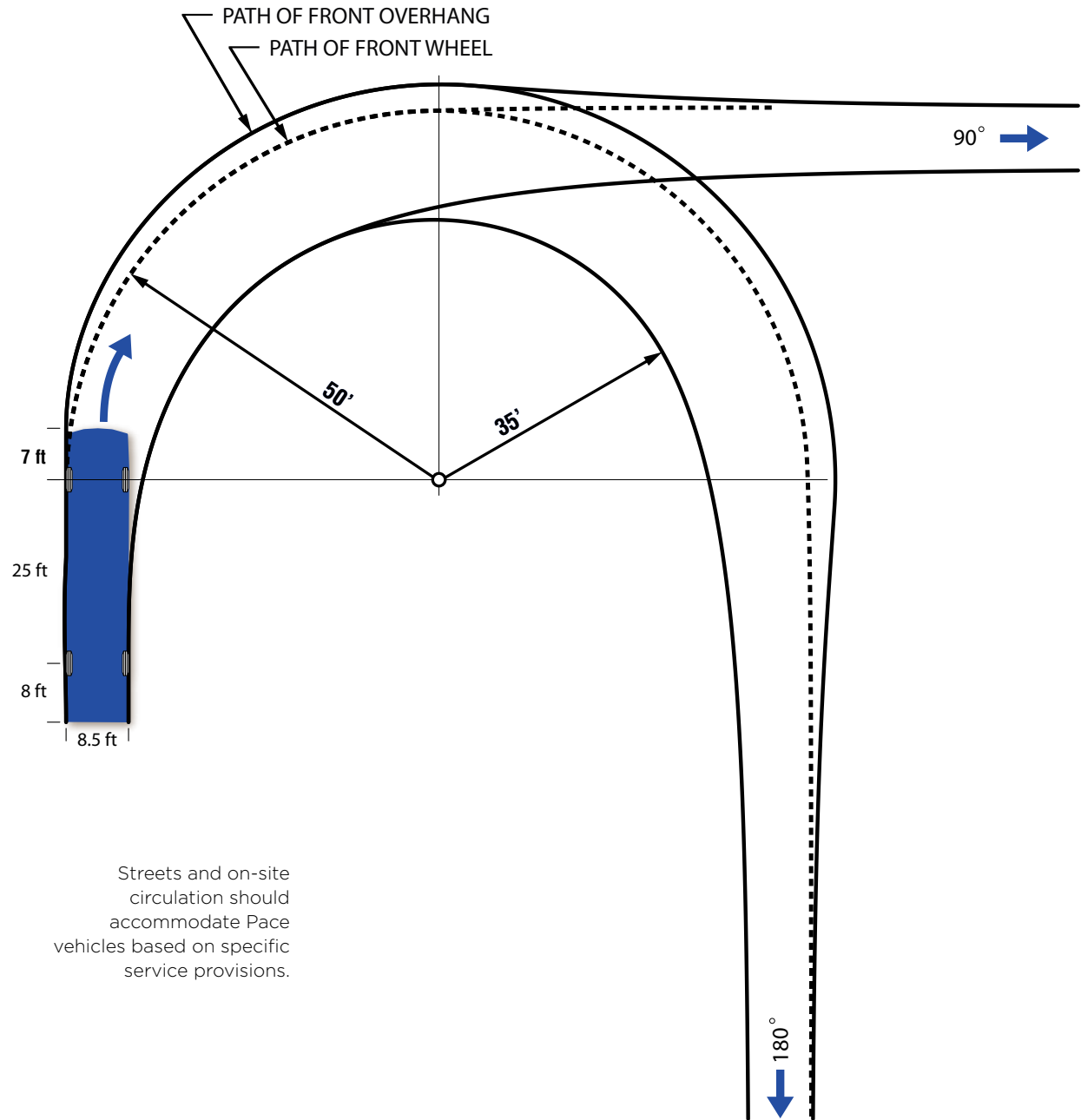

Streets and on-site circulation should accommodate Pace vehicles based on specific service provisions.

ROADWAY GEOMETRICS

When transit service is planned or anticipated along a corridor, it is important to consider bus design and operation characteristics in roadway design. Anticipated vehicle speeds, traffic volume, on-street parking conditions and intersection turning radii are factors that should be considered when designing a roadway or off-street facility that will be serviced by Pace transit vehicles. This section includes a menu of potential roadway elements specifically related to transit. Pace

 planning and engineering staff should be contacted to assist in determining which elements are appropriate or necessary based on transit service and local traffic characteristics. Generally, design standards for these elements meet or exceed IDOT standards.

LANE WIDTHS

For all roadways that accommodate transit vehicles, Pace recommends a 12-foot lane width (minimum) for the curb lane to insure proper maneuverability of its vehicles. However, in areas with constrained right-of-way or high levels of pedestrian crossing activity, 11-foot lanes may be used. Refer to IDOT's Bureau of Local Roads and Streets Manual for information regarding variations in lane width.

iii

GRADES

Pace recommends minimal grades to the extent possible for roadways serviced by Pace vehicles. Also, changes in grade should be gradual so that buses can easily negotiate changes with adequate ground clearance to promote passenger comfort. At stop locations, the roadway profile should be less than 5% in order to meet the requirements the requirements of the Americans with Disabilities Act (ADA) Accessibility Guidelines.

ROADWAY PAVEMENT

To insure that local municipal standards are adequate for transit service, Pace recommends that pavement be constructed to handle vehicles with loads of 20,000 lbs. per axle. Both rigid (concrete) and flexible (asphalt) pavement designs may be used for roadways, driveway aprons, access aisles, bus stop areas and other locations where heavy bus use is anticipated.

For bus stop areas, including bus bays, bus turnouts, bus bulbs and terminals, rigid pavement design is strongly recommended. Due to loads and shear forces applied to pavement surfaces during bus starting and stopping movements, a rigid pavement surface has the best potential to retain its shape. The pavement should be designed to conform to IDOT standards for Class II roadways. However, if local requirements exceed these standards for commercial and industrial driveways or parking areas, the local standard should be followed.

CURBSIDE BOARDING AREA

Pace's vision for regional suburban bus service includes a seamless transition from the sidewalk to the bus stop and to the transit vehicle. In essence, Pace aims to create a service that is a "sidewalk on wheels," in which riders experience a comfortable, accessible and efficient trip from start to finish. The design of the curbside stop, and the curb itself, will have an impact on how comprehensively Pace can implement its vision. While the specific vehicle characteristics are yet to be determined, engineers and designers should consider critical service concepts that influence the design of the roadway/bus stop interface.

- » Level Boarding entails sidewalk and curb infrastructure that brings the rider to the same elevation as the floor of the bus at the point of boarding. This makes for more efficient boarding for all passengers, but especially those reliant upon wheelchairs, strollers, and other assisted transport. The design of level boarding platforms should consider specific transit vehicles and safety elements such as detectable warning signs and surfaces.
- » Precision Docking is the integration of transit technology and infrastructure that enables a vehicle to dock at a specific point that minimizes distance from the curb and properly aligns the bus with curbside infrastructure. This enables focused design solutions at specific locations that result in a better transit experience for operators and riders.

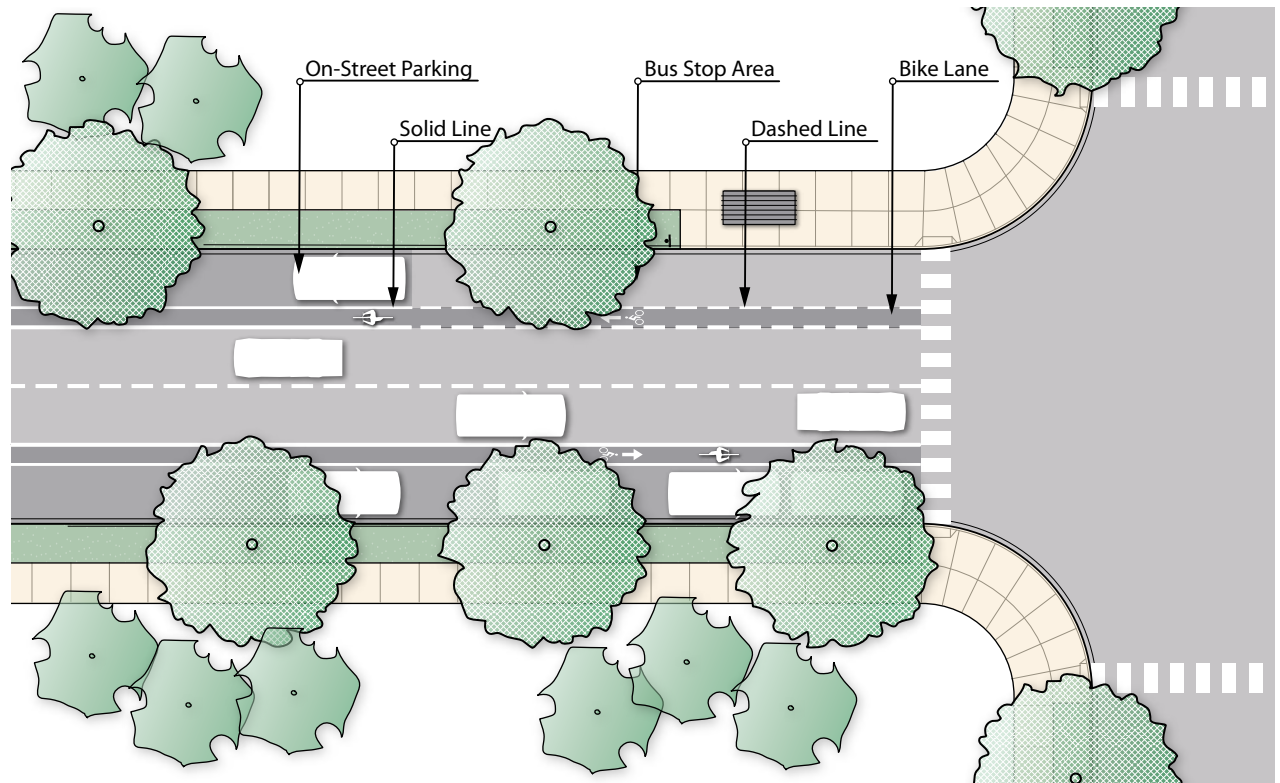

BICYCLE LANES

Clearly marked bicycle paths and bicycle boulevards have the potential to significantly increase the catchment area of a bus stop as individuals will generally bike three to four times as far as they will walk to a bus stop. When a dedicated bicycle lane is provided on the curbside of the right most lane, dotted lines should be provided at the entrance to the bus stop area to indicate to cyclists that a bus may be entering their lane, as described in Section 9C.04 of the [Manual on Uniform Traffic Control Devices \(MUTCD, 2009\)](#).

Additional information on the planning and design of bicycle facilities can be found in Chapter 42 [iii](#) of the [Illinois Bureau of Local Roads and Streets Manual \(IDOT, 2005\)](#) as well as [AASHTO's Guide \[i\]\(#\) for the Development of Bicycle Facilities \(AASHTO, 2012\)](#).

[x](#) see references (page iii)

VEHICLE, SERVICE & ROADWAY IMPLEMENTATION CHECKLIST

Guideline Principles	Implementation Tools
Design standards are used that reflect specific transit vehicles to be used in the development area in terms of lane width, curb radius, pavement construction, etc.	Local subdivision regulations, local public works/engineering standards, D.O.T standards
Design for appropriate outside turning clearance at all locations where Pace vehicles operate.	Local public works/engineering standards, D.O.T standards
For all roadways that accommodate transit operations, appropriate lane widths are used to ensure proper maneuverability of transit vehicles.	Local zoning and subdivision regulations, local public works/engineering standards, D.O.T standards
Design minimal grades to the extent possible for roadways serviced by Pace vehicles and comply with ADA standards at stops and throughout the pedestrian network.	Local public works/engineering standards, D.O.T standards
Pavement should be designed to handle anticipated vehicle loads.	Local public works/engineering standards, D.O.T standards
Consider the long-term implementation of level boarding and precision docking when engineering bus stop areas.	Local public works/engineering standards, D.O.T standards
Bicycle lanes are appropriately integrated into the design of roadway and transit infrastructure.	Local public works/engineering standards, D.O.T standards
Use appropriate lane markers to differentiate between transit areas, bicycle lanes, on-street parking, etc.	Local public works/engineering standards, D.O.T standards

Section 4b

Bus Stop Location & Roadway Design

Bus stop placement directly impacts the convenience and accessibility of the system. The final decision on bus stop locations is dependent on ease of operation, pedestrian transfer situations, space availability, and traffic operations. Pace performs on-site evaluations of proposed bus stops to analyze operating conditions and identify appropriate bus stop locations. All bus stop locations should be designed to accommodate at least one 45-foot bus, with an additional 45 feet of queuing space per vehicle when multiple transit vehicles are expected to utilize the bus stop simultaneously.

Developers and/or municipalities should consult Pace's Transportation Engineer during their initial development planning stages to identify potential bus stop locations and to coordinate the placement of Pace signs.

Pace asks that municipalities place "No Parking" signs at bus stop locations and that local police strictly enforce parking restrictions in these zones.

FAR-SIDE BUS STOPS	52
NEAR-SIDE BUS STOPS	53
MID-BLOCK BUS STOPS	54
ON-STREET BUS STOP CONFIGURATIONS	55
TRANSIT TECHNOLOGIES	58

FAR-SIDE BUS STOPS

- c** Far-side bus stops are located immediately after an intersection, allowing the vehicle to pass through the intersection before stopping for passenger loading and unloading. When the bus reenters the traffic stream, the upstream signal regularly generates gaps in traffic allowing buses to reenter the traffic lane. Far-side stops require shorter deceleration distances and provide for additional right turn capacity by eliminating bus blockage within the curb lane on the approach to the intersection. Additionally, the location of the stop encourages pedestrians to cross behind the bus.
- iii** For these safety and capacity benefits, far-side stops are preferred by IDOT (Bureau of Local Roads & Streets Manual, Special Design Elements, IDOT, pg. 41-4(1), 2006) and Pace if traffic signal and geometry conditions are favorable.

During peak periods, however, when bus queuing is possible, intersections may be blocked by buses waiting to access the bus stop. The act of accelerating at an intersection and then immediately decelerating at the bus stop has the potential to increase the number of rear-end collisions. Additionally, queued buses may restrict sight distances for crossing vehicles and pedestrians.

- x** see the Technical Appendix **x** see references (page iii)

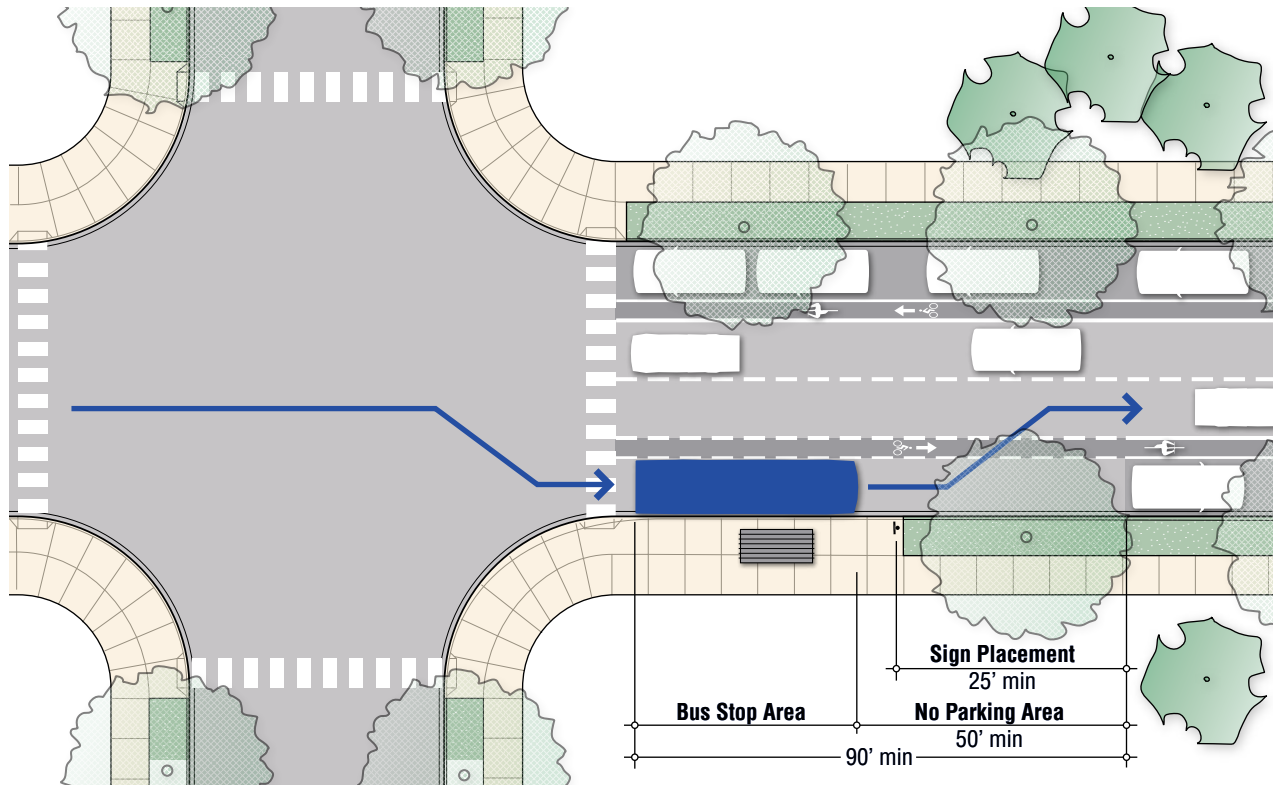

ADVANTAGES

- Saves running time of the route
- Eliminates conflicts with right turning vehicles
- Facilitates bus reentry into the traffic stream
- Requires shorter deceleration distance
- Encourages pedestrians to cross behind the bus

DISADVANTAGES

- Potential for intersection blockage by queued buses
- Potential for increased rear-end collisions
- Obstructed sight distances for crossing vehicles and pedestrians

RECOMMENDED USES

- When near-side traffic is heavier than far-side traffic
- At intersections with heavy right turn volumes
- At intersections with transit signal priority

NEAR-SIDE BUS STOPS

- c** Near-side bus stops are located immediately before an intersection, allowing for passenger unloading and loading while the vehicle is stopped at a red light, preventing double-stopping. When the bus is ready to reenter the traffic stream, the intersection is available to assist in pulling away from the curb and provides the driver with an opportunity to look for oncoming traffic and pedestrians. Near-side stops also allow passengers to board the bus immediately adjacent to the crosswalk, minimizing walk distances.

During peak periods, however, queued buses may block the through lane on the approach to the intersection, potentially disrupting traffic flow. The stop configuration also generates conflicts with right turning vehicles, and delays associated with loading and unloading may lead to unsafe driving in which right turning vehicles drive around the transit vehicle to make a right turn in front of a bus. Additionally, queued buses may restrict sight distances for crossing pedestrians.

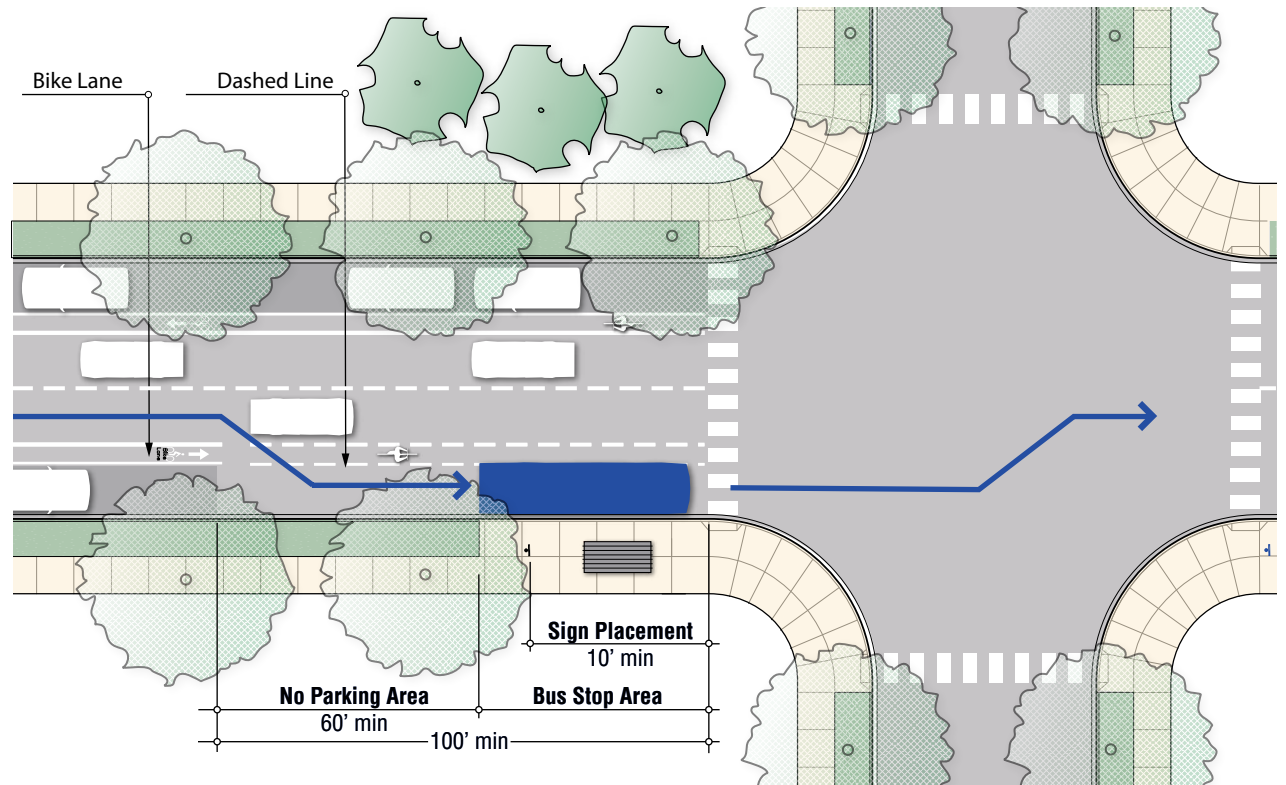

ADVANTAGES

- Allows transit drivers to utilize the intersection and available sight distance when pulling away from the curb
- Provides pedestrian access closest to the crosswalk

DISADVANTAGES

- Potentially creates double stopping at intersection
- Generates conflicts with right turning vehicles
- Potential for through lane blockage by queued buses
- Obstructs sight lines for crossing pedestrians
- May result in increased delay to buses and other vehicular traffic

RECOMMENDED USES

- When far-side traffic is heavier than near-side traffic
- At intersections with pedestrian safety concerns on the far side

x see the Technical Appendix

MID-BLOCK BUS STOPS

- c** Mid-block bus stops are located between intersections, which are generally less congested locations than intersection stop locations. As pedestrian crossings are less common at mid-block stops, vehicle and pedestrian sight distance concerns are typically minimized, but the distance passengers must travel between the bus and a protected crosswalk is increased. These stops can be paired with major mid-block generators to reduce walking distances for the majority of transit users at the stop.

Mid-block stops should generally be used only under special circumstances. However, they increase walking distances for transit users crossing at the nearest intersection, and even encourage illegal mid-block street crossings. Additionally, mid-block stops require both deceleration and acceleration areas, requiring either additional no-parking restrictions or increased turnout construction costs compared intersection stops.

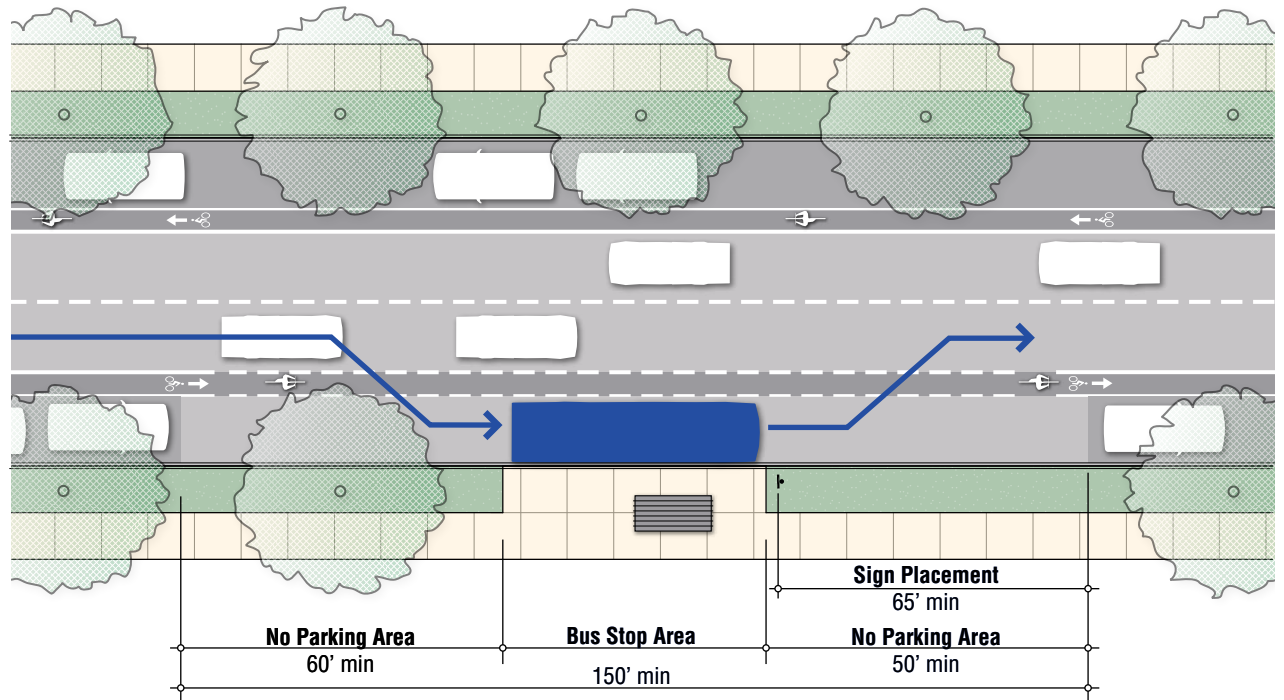

ADVANTAGES

- Less overall traffic congestion
- Minimized sight distance concerns
- Ability to directly serve mid-block generators

DISADVANTAGES

- Encourages unsafe pedestrian crossings
- Increased walking distances for users crossing the street
- Increased construction costs or no-parking restrictions

RECOMMENDED USES

- When there is a major mid-block passenger generator
- When the interval between adjacent intersections exceeds stop spacing recommendations

x see the Technical Appendix

ON-STREET BUS STOP CONFIGURATIONS

The design of bus stops has a significant influence on construction costs, parking restrictions, and the impact of transit vehicles on traffic flow characteristics. All stop locations should be examined to determine traffic volumes, traffic speeds, passenger volumes, bus frequencies, bus dwell times, crash patterns, pedestrian and bicycle facilities, roadway geometrics, accessibility, and planned roadway improvements. Types of bus stop designs include bus bays, turnouts, and bulbs.

For bus stop areas, including on-street stops, bus turnouts and terminals, the rigid roadway surface is strongly recommended. This pavement surface has the best potential to retain its shape when exposed to loads and shear forces applied during bus starting and stopping. The pavement should be designed with a minimum 8" portland cement concrete jointed reinforced pavement on a 4" subbase of stabilized granular material. This complies with IDOT's Bureau of Design Manual. However, if local standards require additional reinforcement, the stronger standards should be used.

BUS BAYS

Bus bays consist of a dedicated zone on the side of the roadway for passenger loading and unloading and are commonly created through the restriction of parking and curb-side operations of other vehicles. Bus bays may be used for far-side, near-side, or mid-block stops. All bus bays require a deceleration zone, a stopping zone, and an acceleration zone. Depending on the location

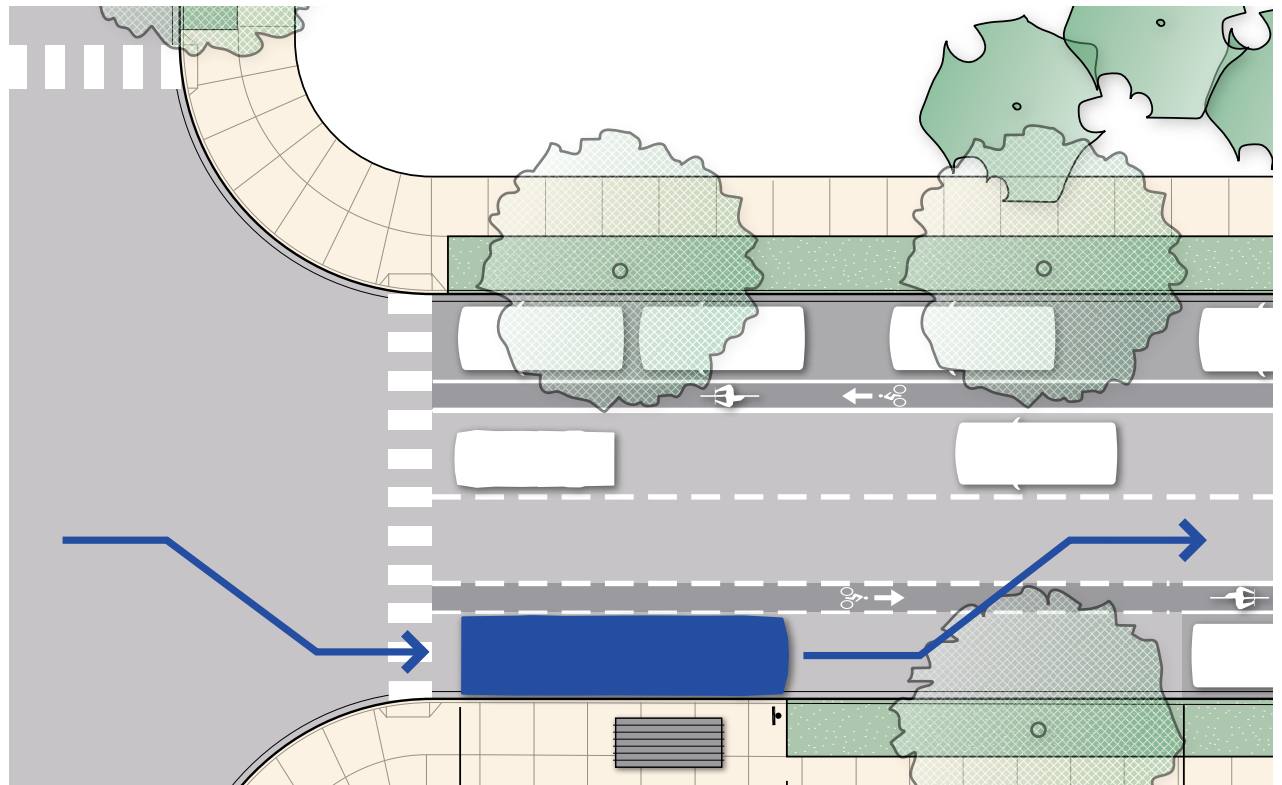

of the bus bay, the intersection may serve as the acceleration or deceleration zone. If conflicts with parked vehicles are encountered, bus bays may also be constructed using a 'closed' configuration, with tapered curbs marking the bus stop zone, preventing encroachment by parked vehicles.

Bus bays prevent the need to block a travel lane during passenger loading and unloading. Bus bays have the potential to reduce rear-end collisions as buses pull out of the lane to come to a stop. However, merging back into the travel lane may be challenging during peak hours, increasing the potential for side-swipe or rear-end collisions on reentry. Bus bays also require the restriction of more on street parking. Bus maneuvers at stops may also generate potential conflicts with cyclists when a bicycle lane is provided.

According to IDOT's Bureau of Local Roads and Streets Manual, bus bays are most effective when:

- iii » Curb parking is provided.
- » The average bus dwell time generally exceeds 30 seconds per stop.
- » Buses expect to layover at the end of the trip.
- » Potential vehicular/bus conflicts warrant the separation of transit and other vehicles.
- » Sight distances prevent traffic from stopping safely behind the bus.

X see references (page iii)

BUS TURNOUTS

e Bus turnouts consist of an entrance taper, a deceleration zone, a stopping zone, an acceleration zone, and an exit taper. They require the curb to be setback to bring the bus vehicle out of the flow of traffic, and can be used only at mid-block.

Bus turnouts do not block a travel lane during passenger loading and unloading and reduce the potential for rear-end collisions by allowing buses to turn out of the travel lane before decelerating ahead of the bus stop. Acceleration distance is provided ahead of the taper to allow the vehicle to merge back into traffic at higher speeds. Curb delineation also helps to guide the bus operator into the bus stop.

Bus turnouts typically have higher construction costs. They rely on otherwise unutilized pavement space for deceleration and acceleration. Bus turnouts remove more potential on-street parking space than bus bulbs, and create potential conflicts with cyclists if on-street bicycle lanes are provided.

iii According to IDOT's Bureau of Local Roads and Streets Manual, turnouts are most effective when:

- » Street provides arterial service with high speeds.
- » Bus volume is 10 or more during the peak hour.
- » Passenger volume exceeds 20 to 40 boardings per hour.
- » Average bus dwell time exceeds 30 seconds.
- » During peak hour traffic, there are at least 250 vehicles per hour in the curb lane.

x see the Technical Appendix

x see references (page iii)

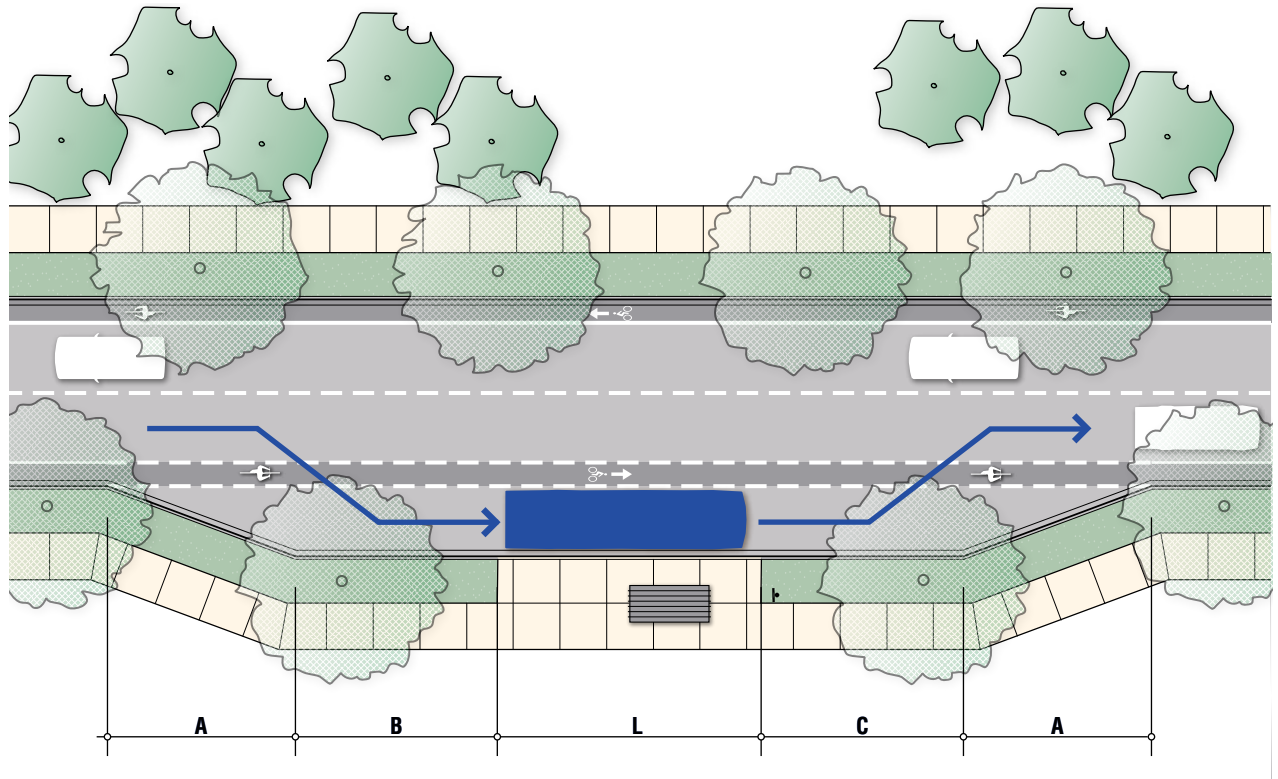

- » Buses expect to layover at the end of the trip.
- » Potential vehicular/bus conflicts warrant the separation of transit and other vehicles.
- » There is a history of traffic crashes and/or crashes involving pedestrians.
- » Right-of-way width is sufficient to prevent adverse impacts on pedestrian movements.
- » Curb parking is prohibited.
- » Sight distances prevent traffic from stopping safely behind the bus.
- » Appropriate bus signal priority treatment exists at the intersection.

Design Speed	Entering Speed	A Suggested Minimum Taper Length	B Minimum Deceleration Length	C Minimum Acceleration Length
30 mph	20 mph	150'	120'	50'
35 mph	25 mph	170'	185'	250'
40 mph	30 mph	190'	265'	400'
45 mph	35 mph	210'	360'	700'
50 mph	40 mph	230'	470'	975'

Note: L=45' for each bus that needs to queue in the turnout. (See Section 4a for vehicle characteristics). Source: Bureau of Local Roads and Streets Manual, Special Design Elements, IDOT, pg. 41-4(6), 2008

BUS BULBS

Bus bulbs are a modified form of curbside stops where the sidewalk extends towards the travel lane, allowing the bus to remain in the rightmost travel lane when picking up and dropping off passengers. Bus bulbs can be used at near-side, far-side, or mid-block locations, and the bulb typically replaces a small section of on-street parking to allow passengers to safely reach the bus.

Bus bulbs eliminate the need for any diverging and merging into the traffic stream, increasing the efficiency with which buses are able to stop, load and unload passengers, and continue. The bus bulb area provides additional space for waiting transit patrons, allowing for additional amenities and better wheelchair access, while removing passengers from pedestrian flow on the sidewalk. When a crosswalk is also provided, bus bulbs decrease the total walking distance for passengers crossing the street.

Bus bulbs require buses to wait within the travel lane while passengers load and unload, potentially generating congestion. Buses stopping in the travel lane may also lead to rear end collisions, or results in unsafe passing maneuvers under congested conditions. Bus bulbs also typically require an infrastructure investment and are more expensive than curbside stops or bus bays with simple parking restriction signs.

Additionally, bus bulbs provide a geometric option for incorporating bicycle lanes through the stop area, reducing potential bus-bike conflicts at stops.

iii According to IDOT's Bureau of Local Roads and Streets Manual, bus bulbs are most effective when:

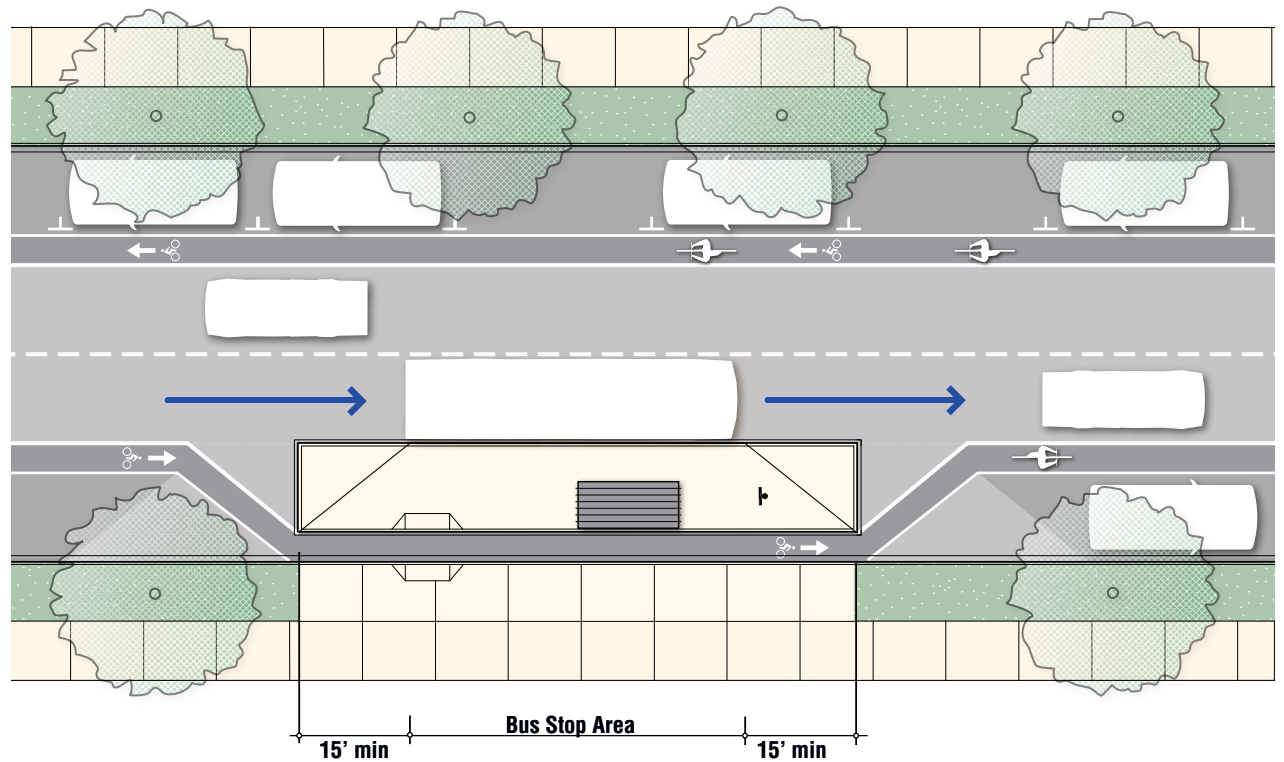

- » Curb parking is provided.
- » The street provides arterial service with lower speeds (e.g., posted speeds of 35 mph or less).
- » Bus volumes are 10 or less during the peak hour.
- » Passenger volumes do not exceed 20 boardings an hour.
- » The average bus dwell time is generally less than 30 seconds per stop.
- » During peak hour traffic, there are less than 250 vehicles per hour in the travel lane.
- » Sight distances allow traffic to stop safely behind the bus.



Courtesy seattletilesbikes.org



Courtesy streetsblog.org

X see references (page iii)

TRANSIT TECHNOLOGIES

Several transit technologies can be used to enhance 'persons through-put' without major modifications to physical infrastructure. Persons through-put is the measurement of the movement of all users of the transportation system - motorists, pedestrians, cyclists, and transit riders - through a specific location, rather than focusing simply on the number of motorized vehicles.

QUEUE JUMP & BYPASS LANES

Queue jump and bypass lanes are a geometric form of Transit Signal Priority in which buses are allowed to use restricted lanes to bypass queued vehicles at signalized intersections, reducing travel time and providing improved service reliability.

A queue jump allows a bus to enter into a short lane, that could also be utilized as a right turn lane, that is located adjacent to the through lane, stopping at the near side of the intersection. A separate signal would provide an early green light to the bus to move through the intersection and into the through travel lane prior to the general traffic. Near side bus stop stops are typically used with queue jump lanes.

A bypass lane, which would be adjacent to the through lane, would not have a separate signal, but would continue through the intersection with the general traffic into a receiving lane on the opposite side of the intersection prior to entering into the through lane. Far side stops are typically used with bypass lanes. These are both alternatives to providing mainline transit signal priority.

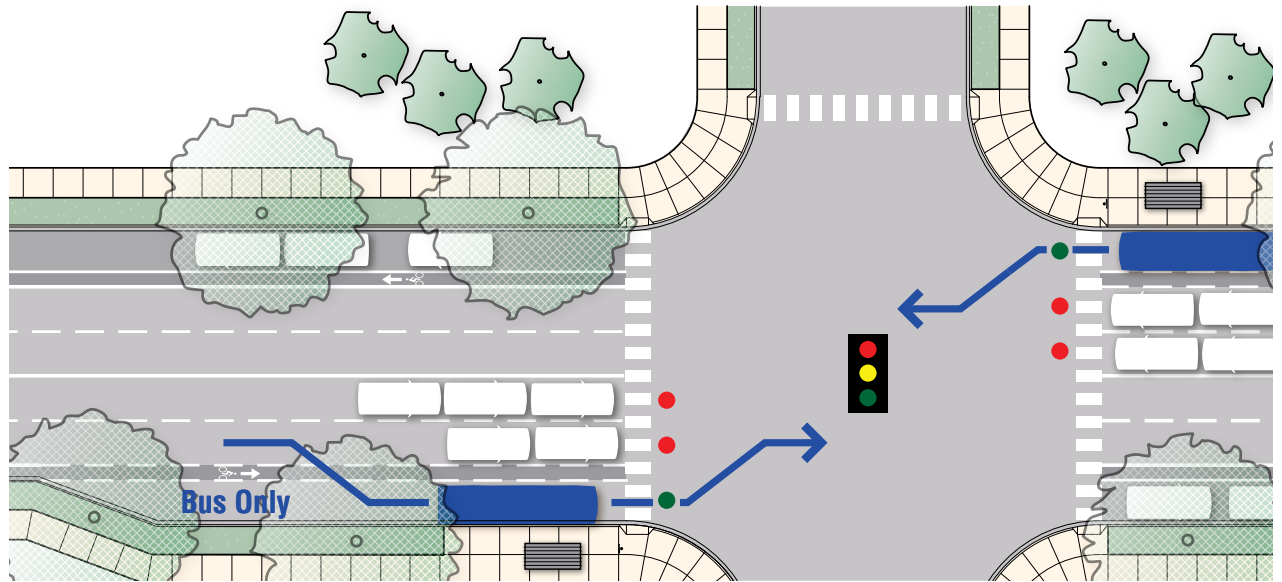

Several U.S. cities, such as Portland, Denver, San Francisco, Las Vegas and Seattle, have implemented queue jump and bypass lanes into their transit systems.

According to the USDOT Transit Signal Priority Handbook, queue jump lanes provide the greatest benefit in the following situations:

- » Heavy congestion.
- » Existing right turn lanes are available or there is available right-of-way to construct an a lane adjacent to the through lane. Existing roadway shoulders can be utilized if they are wide enough (10-foot minimum) and the pavement is designed to accommodate buses.

- » Relatively low right-turn volume at intersection. High right-turn volumes may conflict with through bus movements and may warrant a separate right turn lane.
- » Implementation of Transit Signal Priority (TSP) in the through lanes would have an unacceptable impact on bus travel times and/or general traffic delay.

TRANSIT SIGNAL PRIORITY (TSP)

Delay from signalized intersections typically accounts for around 10 to 20 percent of all bus delay. A variety of techniques can be implemented at intersections with traffic signals to reduce transit delay and improve service reliability. These techniques include transit signal priority (TSP). *Transit Signal Priority (TSP): A Planning and Implementation Handbook*, published by ITS America, recommends a systems engineering approach, including; planning, design, implementation, operations/maintenance, and evaluation/verification/validation.

Through this approach Pace will work closely with a number of stakeholders, including IDOT, other DOT's and local jurisdictions, to measure the need for TSP, develop TSP strategies and work through the design and specification process.

Several communities in the Chicago region have begun testing TSP systems. In 2010, the Harvey Area TAP Demonstration Project (Phase 1) was completed. The project area includes three Pace bus routes, and included technology upgrades to 20 intersections and 55 buses. Evaluation of the impacts showed benefits to both Pace, in terms of operating cost and on-time operations, and to the rider, in terms of travel time.

- Bus Travel times were reduced up to 15%.
- Cumulative Daily Delay for buses was reduced by 27 minutes at TSP- equipped intersections during AM and PM Peak Periods.
- Average travel time for all traffic was reduced by as much as 6 minutes during peak hours.

Active Transit Signal Priority

Active signal priority refers to a variety of real-time strategies designed to provide priority for a specific transit vehicle approaching an intersection. Active signal priority requires the installation of a detection system to allow transit vehicles to request priority while approaching an intersection and a priority request generator system that is able to handle multiple simultaneous requests and relay the information to the traffic control system. There are two types of active TSP: signal preemption and signal priority. Signal preemption, in which the traffic control device terminates normal operation in order to serve the approaching vehicle, is used primarily for emergency response vehicles. Therefore, Pace does not support the use of preemption for bus transit operations.

Signal Priority takes into account the time at which the request for priority was made, and modifies the normal signal operation to provide preferential treatment for the vehicle making the priority request without necessarily disrupting operations.

Common types of priority timing plan modifications include green extension (extending the green time for the priority movement to allow the approaching vehicle to continue without stopping), early green (shortening the preceding phases to minimize red time on the priority approach), phase insertion (inserting a special priority phase into the normal signal sequence), and phase rotation (modifying the order of signal phases).

Signal priority requires a more sophisticated controller system that is able to compare the time of the request to the real-time signal phasing. More advanced signal systems combined with real-time traffic detection systems allow for adaptive signal priority strategies, that assess real-time conditions based on a number of performance criteria, such as person, transit, or vehicle delay, and implement timing plans optimized based on the current state of the system.

Passive Transit Signal Priority

Passive TSP requires little or no hardware and software investment. In general, when transit operations are predictable with a good understanding of routes, passenger loads, schedule, and/or dwell times, passive priority strategies can be an efficient form of TSP. Timing plans are developed to take into account the operational characteristics of transit service within the corridor, such as the average dwell time at stops. This typically results in a setting the traffic signals to a lower speed in order to accommodate the transit vehicles, which results in more buses arriving at the intersection during a green signal. This system may cause unnecessary delays, stops and frustration for other vehicular traffic within the corridor. Cities that have implemented passive TSP include Washington, D.C., College Station, TX, Ann Arbor MI, and Austin, TX.

BUS STOP LOCATION AND ROADWAY DESIGN IMPLEMENTATION CHECKLIST

Guideline Principles	Implementation Tools
Working closely with Pace, determine the appropriate location for transit stops and facilities based on local conditions.	Local public works/engineering standards, D.O.T standards
Design appropriate clearances from on-street parking, intersections, etc. based on the location of the bus stop.	Local public works/engineering standards, D.O.T standards
To the extent possible, use rigid roadway surfaces at bus stops, bus turnouts, and transit terminals.	Local public works/engineering standards, D.O.T standards
Coordinate with Pace in selecting appropriate bus bay configurations to ensure efficient bus service on busy streets.	Local public works/engineering standards, D.O.T standards
Coordinate with Pace to implement suitable transit technologies (such as queue jumps and transit signal priority) when roadway geometry and traffic conditions permit	Local public works/engineering standards, D.O.T standards

Section 4c

Off-Street Facilities

Proper design of off-street facilities can be just as important to the overall efficiency, safety, convenience, and comfort of the transit system as on-street systems. Design of these facilities presents an opportunity for integration with surrounding land uses, including mixed use development and existing structures. It is also an opportunity to ensure that stops and services are fully accessible for all users. Regardless of location, taking into account the appropriate turning radii, space requirements at queuing areas, and efficient loading and unloading configurations at off-street facilities will minimize the land area required for these facilities while optimizing the functionality of the overall system and enhancing user perceptions of the system as a whole. While the size of any given off-street facility will vary based on ridership, the number of routes served, and other on-site amenities, this section provides principles that can be applied throughout the region.

BUS BERTHS 62

BUS TURNAROUNDS 65

PARK-N-RIDE FACILITIES 66

BUS BERTHS

g Bus berths are recessed bus stop areas designed to accommodate more than one transit vehicle. Similar in concept to bus turnouts, bus berths provide convenient, off-street service points and bus staging areas that do not interfere with traffic movement. Bus berth designs, parallel or sawtooth, also can be incorporated into transportation center, transfer facility and park-n-ride site plans for passenger loading and unloading as well as for bus layovers.

☎ Pace's transportation engineer should be consulted to determine the bus bay capacity at specific locations.

The bus berth should be constructed with concrete landing pads to prevent the buckling of pavement and should be designed to accommodate the largest bus size planned to use that particular facility. Where feasible, the bus berth should be separated from roadways and drive aisles utilized by other vehicles. Barriers may be particularly important for facilities located adjacent to high speed roadways.

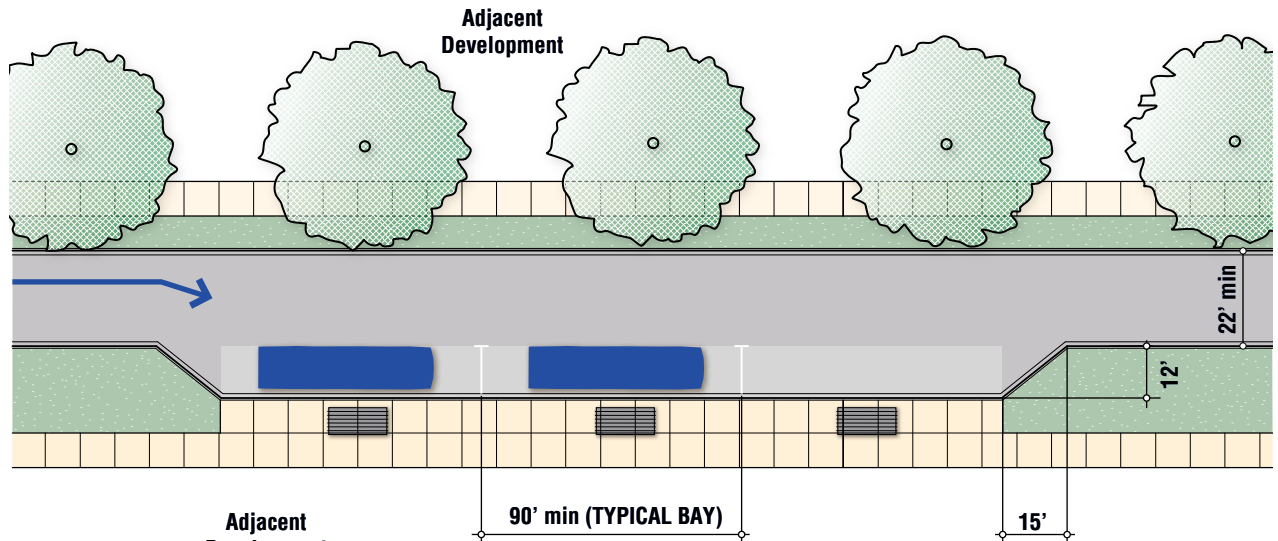

PARALLEL CURB-SIDE BUS BERTHS

Parallel curb-side bus berths should be located adjacent to the proposed bus stop stop and should be a minimum of 90-feet long and 12-feet wide for each bus that would be queued at the bus stop at any given time. A minimum of 20-feet should be provided between queued buses in order to allow queue buses to enter/exit the parallel bus berth. Within the park and ride facility, a travel lane should be provided adjacent to the parallel bus berth to allow through buses to pass queued buses.

x see the Technical Appendix **☎** contact Pace staff

SAWTOOTH

g Sawtooth bus berths may also be utilized within a park and ride facility. Sawtooth bus berths direct bus traffic directly towards pedestrian-occupied areas and positive separation, in the form of bollards, should be provided to stop a bus from inadvertently entering into the pedestrian area. Bollards should be placed at the forward ends of saw tooth bus parking spaces.

☎ Pace's transportation engineer should be contacted to determine the appropriate location and specifications for bollards and other safety resources.

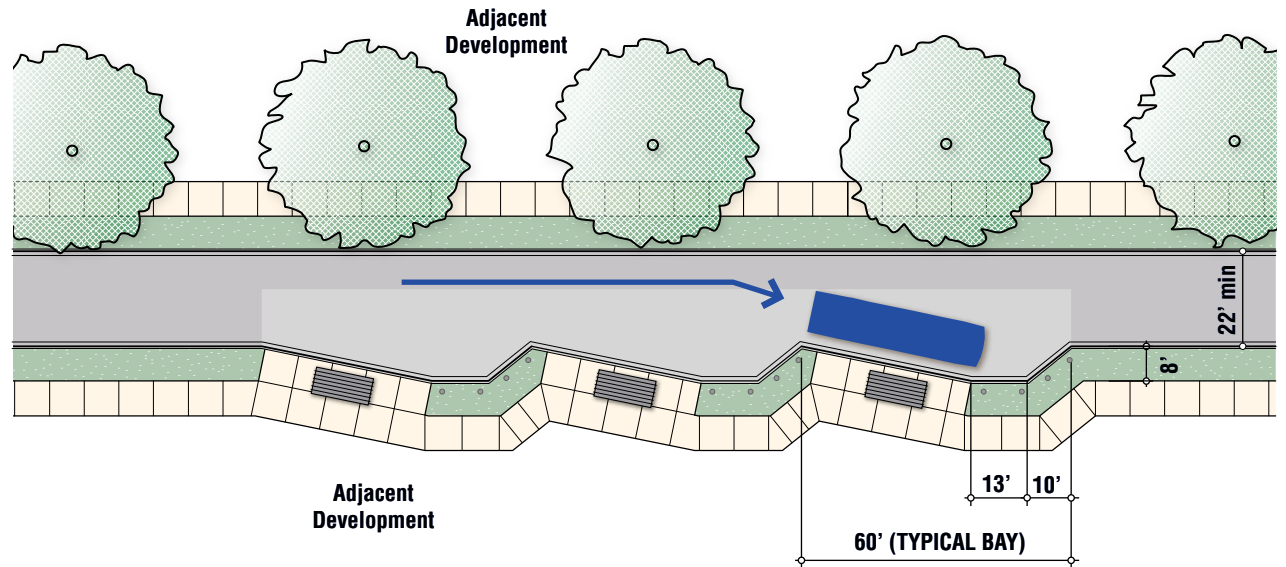

LATERAL BAY BUS BERTHS

Lateral bay bus berths are commonly used in park and ride facilities and transit transfer and terminal locations. In this configuration, lateral bays are placed side-by-side with passenger islands located between vehicle bays. Clearly marked crossing areas are provided so that vehicles stop short of pedestrian access to other waiting areas, and bays are typically designated to serve specific routes, enhancing operations and predictability for waiting riders.

Bus berths should be used at park and ride facilities as well as areas where transit routes intersect and bus waiting areas are appropriate. If these type of facilities are provided for an on-street facilities they should be located at mid-block locations rather than intersections to avoid conflicts with turning vehicles and to take advantage of gaps in traffic produced by traffic signals. To allow buses to more effectively re-enter traffic, bus berths should be designed so that vehicle operators have clear rear-vision capabilities. Bus berth widths of 15 feet - with appropriate pavement markings and signage - are desired for more effective and proper vehicle maneuverability where no barrier separation exists. However, Pace will evaluate barrier separation needs on a case by case basis.

Lighting for safety at boarding and circulation areas is important for both on and off-street locations.

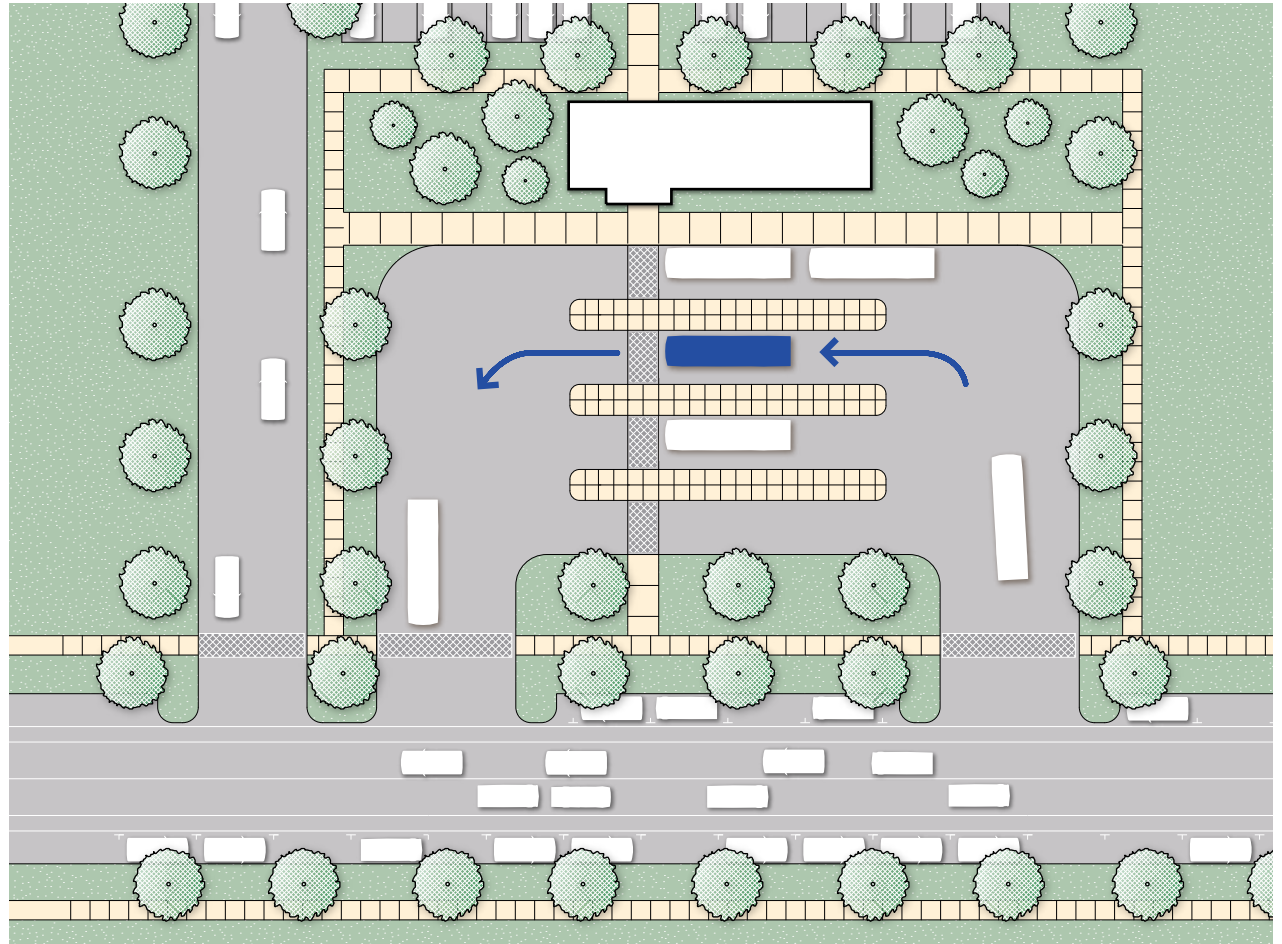

Since many factors are involved in the design and location of these facilities, [developers should consult Pace](#) for assistance during the site plan development stage.

 contact Pace staff

BUS TURNAROUNDS

h Bus turnarounds are roadway facilities that expedite a bus' return to the service route. These facilities can be used at the termini of routes to turn transit vehicles or they can be incorporated into a development's site design. Turnarounds can improve schedule adherence and service reliability. These roadway facilities also provide effective, off-street waiting and service areas for transit users. Site considerations and passenger requirements will determine the location of the passenger waiting area.

Bus turnarounds should be designed so the bus can be turned in a counter-clockwise direction to improve the drivers' visibility. Additionally, the design should allow adequate space for a bus to pass a transit vehicle that may be loading/unloading passengers or have a mechanical breakdown. A 30-foot roadway width typically permits passing within a turnaround.

The "jug handle" bus turnaround design can be used at appropriate mid-block bus terminal locations to turn a transit vehicle. Proper signage or traffic signals along the roadway and at the turnaround may be needed for traffic control purposes and to expedite the return of the transit vehicle to its route.

The "cul-de-sac" and "loop" designs are acceptable for developments that do not have internal roadway networks to return a bus efficiently to an arterial roadway. Note, however, that transit operations are most efficient when provided on through streets. Therefore, "cul de sac" and "loop" turnarounds are typically located at the end of bus routes in appropriate locations, however they can be used in other situations.

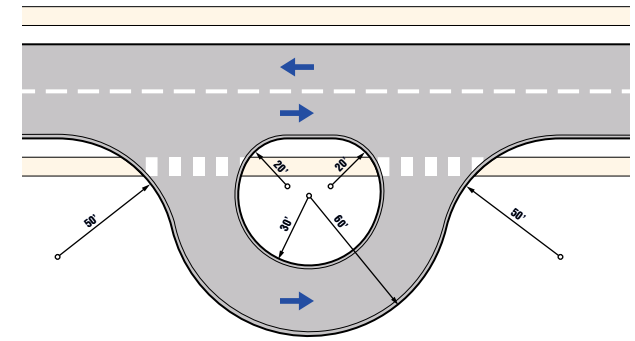

Jug Handle

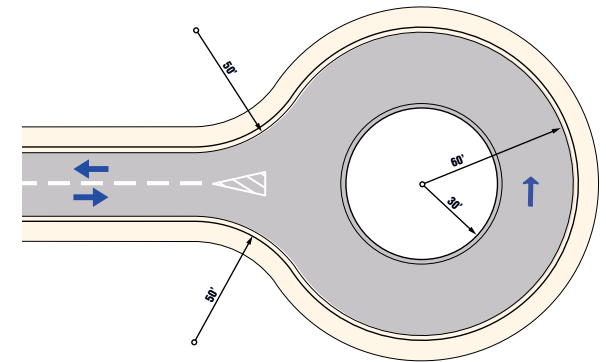

Cul-De-Sac

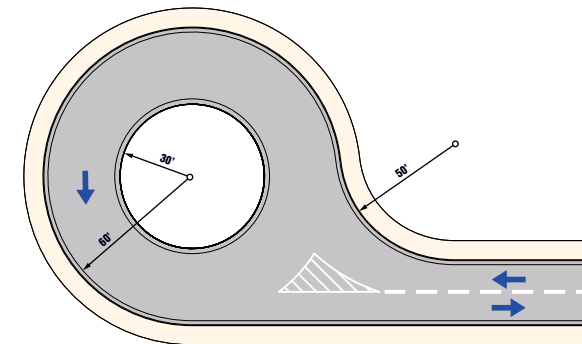

Loop

X see the Technical Appendix

PARK-N-RIDE FACILITIES

The design of an off-street facility is typically not standardized, but is instead based on the size, function and location of the specific facility. Bus berths and bus turnarounds should be incorporated into the design of the parking facility to provide safe and efficient bus service. The design of the parking facility should be guided by Pace’s Passenger Facility and Park-n-Ride Guidelines. This document identifies a range of park-and-ride facilities that can provide initial context for the coordination between local municipalities and Pace. The table below summarizes the hierarchy of potential facilities. Consideration should be given to facilities that are initially designed to accommodate smaller park-n-ride operations, but may be expanded to accommodate increased ridership or expanded services.

Parking Facility Size

The number of parking stalls to be provided at an off-street facility should be based on the existing and projected transit ridership. General guidance for parking lot size identifies that approximately 90 to 100 stalls can fit on one acre of land. The local municipality code should be reviewed to determine parking space and aisle dimensional requirements.

Accessible parking spaces serving the transit facility should be located on the shortest accessible route of travel from adjacent parking to the transit facility. The number of accessible stalls required  shall follow [ADA Accessibility Guidelines](#). The facility design should incorporate measures to reduce pedestrian/automobile conflicts to promote the overall safety of the facility.

Vehicular Access

Access to the off-street facility should be at points that create as little disruption to existing traffic as possible and proper intersection spacing should be maintained based on the roadway classification and jurisdictional requirements. Transit vehicles and automobiles should be separated within the facility to maximize transit efficiency and safety.

Kiss & Ride Waiting Areas

Kiss & ride waiting areas should be located within the parking facility and should provide direct access to passenger waiting areas. Circulation in kiss & ride areas should be one-way and flank the passenger waiting area.

Pedestrian Access

Passenger waiting areas should be provided adjacent to bus loading areas and shelters should be provided. Pedestrians should not be required to walk excessive distances from the passenger shelter of the parking facility to boarding areas. Longer distances may be permitted, depending on size and configuration of the off-street facility. Provisions for bicycle parking should be incorporated into the overall design and should be located adjacent to passenger waiting areas.

Classification	Transit Services	Size	Locational Considerations
Regional	Express bus, regular bus, feeder bus, dial-a-ride, subscription bus, and/or vanpool	500+ spaces	Immediately adjacent to highways or arterials
Subregional	Express bus, regular bus, feeder bus, dial-a-ride, subscription bus, and/or vanpool	76-500 spaces	Within a 5-minute drive time to limited access highways, or adjacent to arterials
Local	Express bus, regular bus, feeder bus, dial-a-ride, subscription bus, and/or vanpool	25-75 spaces	Within a 5-minute drive time to limited access highways, or adjacent to arterials
Vanpool	Feeder bus, dial-a-ride, subscription bus, and/or vanpool	Less than 25 spaces	Within 10 minutes of patron’s residence and 60 minutes of patron’s destination

 see references (page iii)

TRADITIONAL OFF-STREET FACILITY

The diagram above illustrates the configuration and general operational characteristics of a traditional off-street park-n-ride bus facility. In this configuration, the facility sits entirely within a private parcel of land, with access provided from a transit corridor. The bus stop is located to provide easy and safe access from the parking area or public sidewalk. Bus access and circulation is provided through a dedicated entry and “loop,” while vehicular access for cars is provided through a separate entry. This avoids conflicts between pedestrians, buses and cars, and maximizes access between various modes of transportation.

Traditional Off-Street Facility

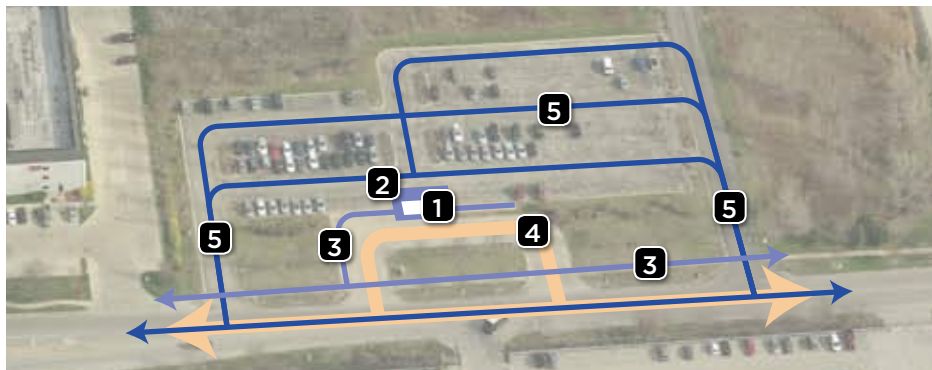

- 1 Bus stop boarding and alighting area
- 2 Passenger waiting area
- 3 Pedestrian circulation paths
- 4 Dedicated bus vehicle access and circulation
- 5 Vehicular parking area access and circulation

EXPRESS PARK-N-RIDE FACILITY

Pace serves portions of the region with express bus service that operates on limited access highways. These routes provide the opportunity for efficient regional mobility, but offer fewer points of access for potential riders. Other regions have implemented express park-n-ride facilities to enhance accessibility. In this configuration, a freeway exit includes a bus-only lane that provides direct access to the transit facility. On-site circulation returns the bus to the arterial network for easy entry back onto the freeway. Cars access the parking area from arterial streets, and the transit center provides convenient parking and a kiss-n-ride drop off area.

The image to the right illustrates how this scheme has been implemented in the Milwaukee region. This type of facility could be implemented in phases. First as a smaller ride-share lot, then upgraded to a full park-n-ride stop with additional parking capacity and investment in infrastructure.

Express Park-n-Ride Facility

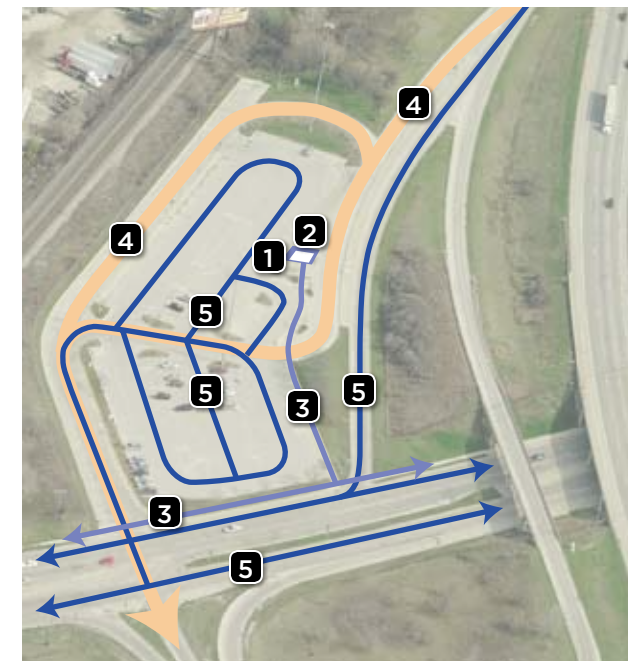

- 1 Bus stop boarding and alighting area
- 2 Passenger waiting area
- 3 Pedestrian circulation paths
- 4 Bus vehicle access and circulation
- 5 Vehicular parking area access and circulation

CURBSIDE PARK-N-RIDE FACILITY

The Chicago region includes many commercial developments with large parking areas located along arterial streets served by Pace buses. In these instances, property owners are encouraged to provide dedicated transit park-n-ride spaces near the arterial street. Parking would generally be used during work day periods when commercial parking demand is low and would occupy parking furthest from commercial structures. This would minimize the impacts on local businesses. A simple pedestrian connection would provide access from the parking area to the public sidewalk near a transit stop.

The image on the right illustrates how this scheme could be implemented in a typical scenario in the Chicago region. The exact location and amount of commuter parking would be dependent upon the location of bus stops, availability of parking at different times of day, and agreements with local property or business owners.

This concept represents a widely applicable opportunity to take advantage of public/private partnerships, and can be encouraged through local incentives that could include reduced on-site parking requirements or increased allowable development intensity.

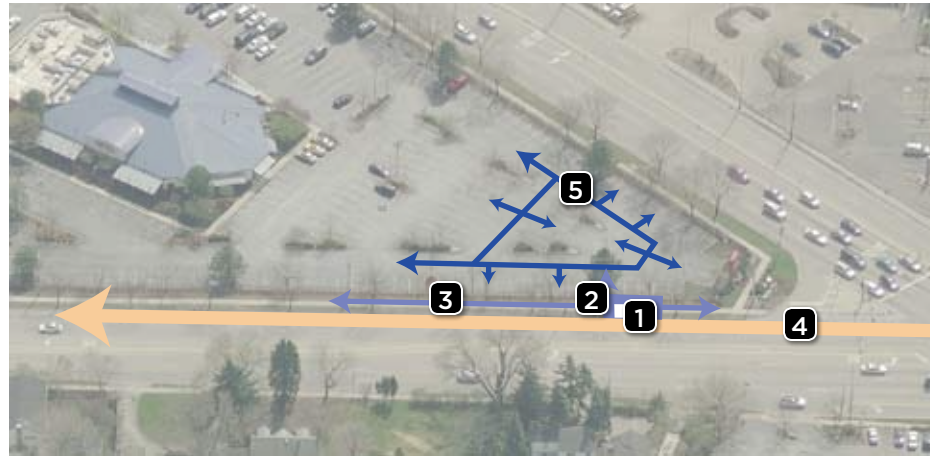

- 1 Bus stop boarding and alighting area
- 2 Passenger waiting area
- 3 Pedestrian circulation paths
- 4 On-street bus route alignment
- 5 Vehicular parking area access and circulation

RAIL TRANSFER FACILITY

There are several locations throughout the region where Pace buses interface with Metra or CTA rail services. The various modes of transit should be as closely located as possible, and direct and fully accessible pedestrian paths should be provided. In some cases, this occurs entirely on-site. However, in other instances, this may require segments of the public sidewalk system to link different transit services. In either case, adequate signage and multi-modal route information should be provided to facilitate easy rider transfers.



- 1** Bus circulation path
- 2** Bus passenger boarding/alighting area
- 3** Pedestrian transfer path
- 4** Rail passenger boarding/alighting area

OFF-STREET FACILITIES IMPLEMENTATION CHECKLIST

Guideline Principles	Implementation Tools
Coordinate with Pace to appropriately integrate off-street bus facilities into development.	Local zoning and subdivision regulations, Local public works/engineering standards, D.O.T standards
Coordinate with Pace to accommodate appropriate bus turnarounds as needed.	Local public works/engineering standards, D.O.T standards
Design bus circulation routes, berths, and turnarounds to accommodate anticipated transit vehicles.	Local zoning and subdivision regulations, Local public works/engineering standards, D.O.T standards
Design park-n-ride facilities that consider parking facility size, waiting areas, and pedestrian access, and incorporate bus berths and turnarounds into design.	Local zoning and subdivision regulations, Local public works/engineering standards, D.O.T standards
Provide a fully accessible pedestrian path between bus boarding/alighting areas, nearby uses and structures, and other modes of transportation.	Local zoning and subdivision regulations, Local public works/engineering standards, D.O.T standards

Section 4d

Passenger Waiting Areas

The passenger waiting area is typically the first element of the transit system encountered by the transit patron and several characteristics significantly impact the user's perception of the system. The passenger waiting area should be easily recognizable, providing a clear indication of transit service along with cues to the level of service provided from the stop. Not all stops require the same number of amenities due to the wide range of services provided.

BUS STOP ACCESSIBILITY 72

BASIC BUS STOP AMENITIES 73

OTHER BUS STOP AMENITIES 78

BUS STOP INFORMATION & TECHNOLOGIES 81

BUS STOP ACCESSIBILITY

Bus stop accessibility for all users should be the first item addressed at all Pace bus stops. As required by IDOT, all bus stop landing pads should be connected to streets, sidewalks or pedestrian paths, and have at least one safe and easily identifiable accessible route. All access ramps, sidewalks, and detectible warning surfaces should comply with current ADAAG standards (United States Access Board, 2006).

CURB RAMPS

Guidance on the design and placement of curb ramps is provided in Chapter 41 of the Illinois

- iii Bureau of Local Roads and Streets Manual (IDOT, 2005) and in Section 4.7 of the ADA Accessibility Guidelines for Transportation Facilities (United States Access Board, 2006). The most up-to-date resource should be consulted during the design of all new curb ramps.
- v

SIDEWALKS

Guidance on the design of sidewalks is provided in Chapter 41 of the Illinois Bureau of Local Roads and Streets Manual (IDOT, 2005) and in Section 4.3 of the ADA Accessibility Guidelines for Transportation Facilities (United States Access Board, 2006). The most up-to-date manual should be consulted to ensure compliance with current standards.

- i-n
- f Refer to the Technical Drawings and Reference section of the Appendix for potential bus stop configurations and dimensions.

DETECTIBLE WARNING SURFACES

Guidance on the design of detectible warning surfaces is provided in Chapter 48 of the Illinois Bureau of Design & Environment Manual (IDOT, 2010) and in Section 4.29 of the ADA Accessibility Guidelines for Transportation Facilities (United States Access Board, 2006). The most up-to-date manual should be consulted to ensure compliance with current standards.

- iv
- v

LANDING PADS

The incorporation of a paved passenger waiting area is recommended to provide a safe, comfortable and convenient waiting area for all transit users and to promote access for those who are mobility limited. Landing pads are required to be provided at all stop locations, no matter if shelters are provided or not. According to IDOT standards, all new bus stop landing pads constructed for use in conjunction with a lift or ramp shall meet the following criteria:

- » Provide a firm, stable surface.
- » Provide a minimum clear length of 8 feet (measured from the curb or roadway edge) and minimum clear width of 5 feet (measured parallel to the roadway).
- » The slope of the pad parallel to the roadway will be the same as the roadway to the maximum extent practical.
- » For drainage, provide a desirable cross slope of 1.5 percent up to a maximum cross slope of 2.0 percent perpendicular to the roadway (Bureau of Local Roads and Streets Manual, Special Design Elements, IDOT, pg. 41-6(2), 2008).

Additionally, landing pads should not be obstructed by any physical features such as utility poles, sign poles, advertising, or other stop amenities.

x see the Technical Appendix

x see references (page iii)

BASIC BUS STOP AMENITIES

Waiting area amenities increase the safety, convenience, usability, and comfort of bus stops, and influence the overall attractiveness of public transportation. Bus stop locations that are designed with paved waiting pads, shelters, benches, lighting, windbreaks, route information, trash bins, bike racks, and, in some cases, pay stations and real-time arrival information, provide a comfortable, safe, and convenient waiting area for transit users. However, even when all these cannot be provided, each bus stop should provide basic amenities to the greatest extent possible.

 All shelter areas and amenities should comply with ADAAG standards (United States Access Board, 2006).

In some cases, building lobbies can be designed as interior waiting areas for transit users. These lobbies should be located within close proximity of a Pace bus stop and face the service area. Transit users should be able to view approaching buses for a 1000-foot distance. For passenger comfort, seating should be provided in the lobby.

Several factors influence the need for various stop amenities. High-ridership route transfer locations, stops with nearby healthcare facilities, and rapidly growing areas, for example, may indicate a need for targeted investment to improve passenger comfort and to draw additional transit users. In general, all new bus stops should be constructed with sufficient space to accommodate all of the amenities listed here, and Pace should be consulted to provide a recommendation regarding the appropriate amenities given specific local services.

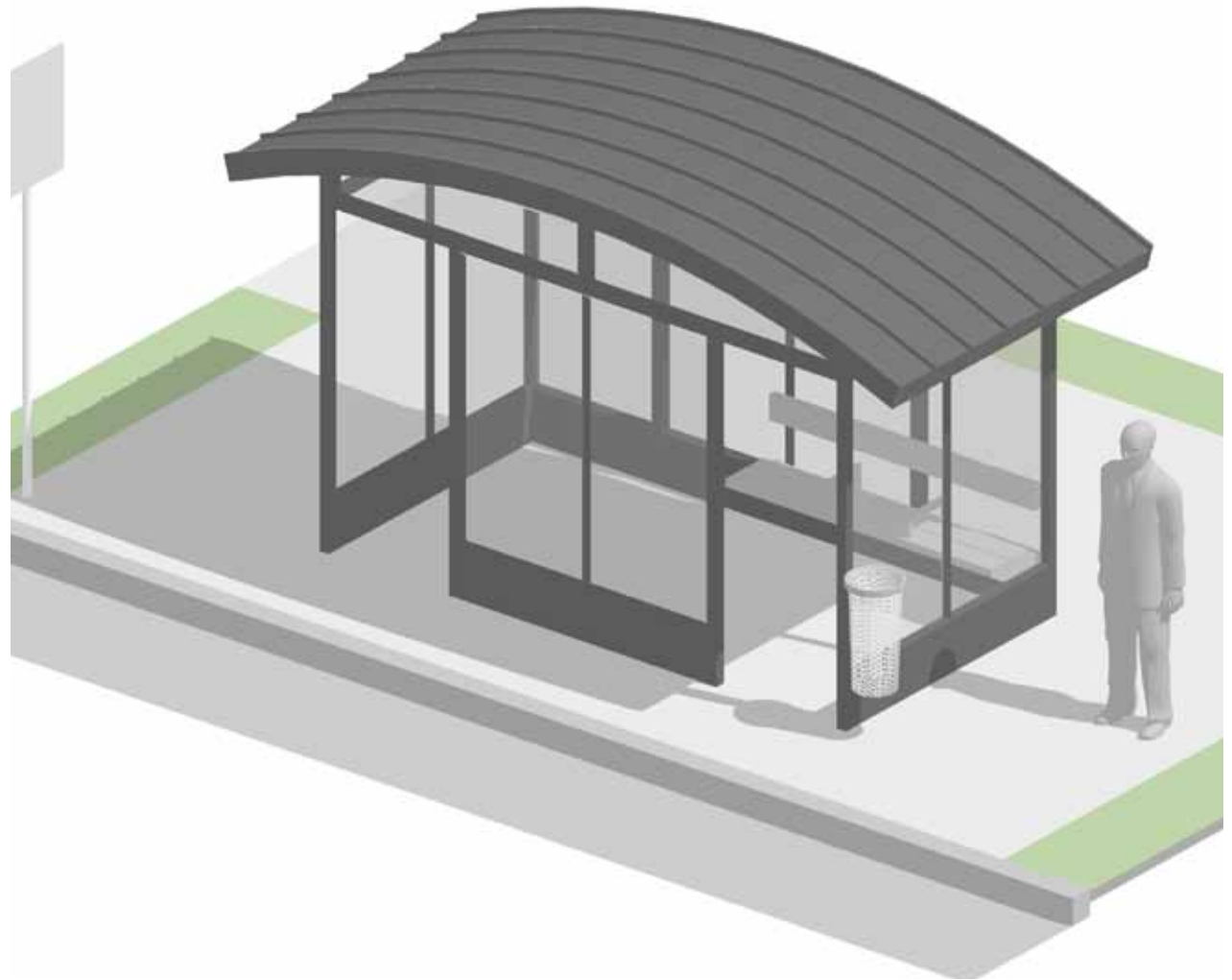

 contact Pace staff

SHELTERS

Passenger shelters are recommended for bus stop areas that are high volume boarding sites. The locations, size and design of passenger shelters will vary depending on space availability and the number of passenger boardings. However, the standard shelter that is accessible to individuals with mobility limitations is 13.5 feet by 6.5 feet, with a minimum clear floor area of 3 feet by 4 feet, and should allow for a clear path for a wheelchair user to enter from the public way. Shelters should have a minimum 5-foot setback from the street at the closest point. When possible, bus stop information is provided on the shelter rather than on a freestanding sign.

Pace shelters may be available to communities at no cost, if the requested shelter can be implemented as part of Pace's Ad Shelter Program. These structures are designed to be constructed on concrete pads that have a minimum 5 inch thickness. If requested, Pace will install the shelters.

Developers and municipalities can provide shelters that are architecturally consistent with particular development designs. Shelter placement should be reviewed by Pace and the local jurisdiction (i.e. IDOT, county or municipality) to avoid visual obstructions to vehicle drivers as well as interference with utilities. The maintenance of these shelters is usually the responsibility of the developer, municipality or other appropriate party. For additional information regarding Pace's shelter program, please contact the Transportation Engineer.



 contact Pace staff

SEATING

Benches are highly desirable at bus stops, and should be integrated with lighting features when a shelter is not available. Benches should be located within the confines of the area where a bus stop shelter would be installed, or adjacent to a shelter with at least three feet of separation. The bench design should be compatible with the surrounding environment, constructed with vandal-resistant materials, compliant with accessibility requirements, and have dividers to designate seats and discourage lying down. The bench design should not create a hazard nor contain advertising that is distracting to motorists.

When installed, seating should comply with the following guidelines:

- » Provide seating space for at least three adults and one wheelchair space.
- » Maintain adequate clearance on the sidewalk and designated walk aisles within the bus stop area.
- » Provide adequate separation between seating and any trash receptacles.
- » Place seating on a stable, non-slippery pad.
- » Integrate seating with lighting.
- » Bench segments should include vertical separators between individual seats.

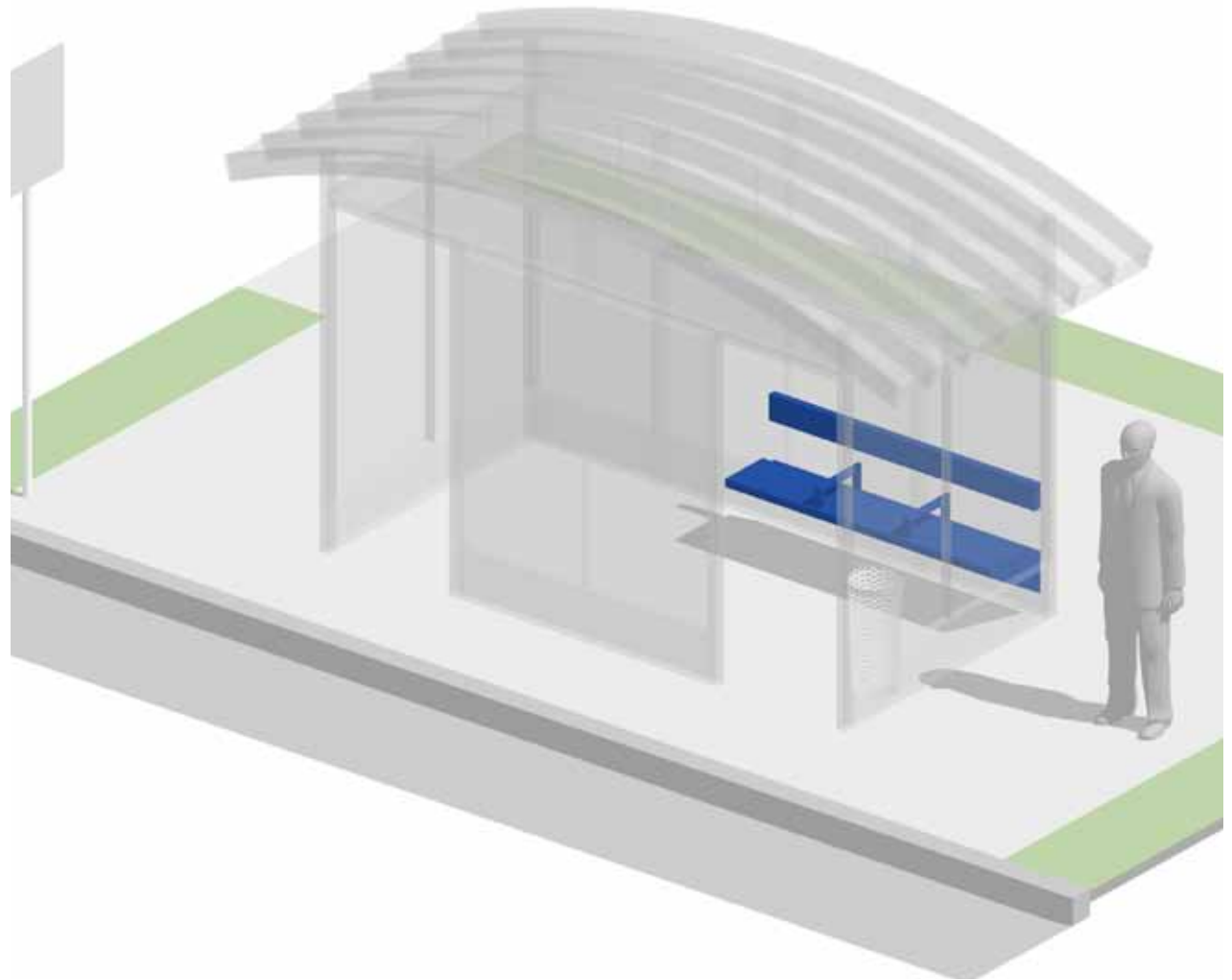

TRASH RECEPTACLES

Trash receptacles provide a number of benefits and should be considered at all bus stops. Providing trash receptacles helps to maintain the overall cleanliness of the stop, improving the health, safety, and comfort of waiting passengers. Carefully designed and sited trash receptacles can even improve the overall aesthetics of the stop area, contributing to the sense of an inviting pedestrian environment.

Trash receptacles require regular pick-up and maintenance, however, and should comply with the following guidelines:

- » Locate out of direct sunlight to prevent odors.
- » Securely mount to the shelter or ground, depending on shelter manufacturer specifications.
- » Provide adequate separation from all standing and seating areas.
- » Maintain adequate clearance on all accessible paths.
- » Design to deter harmful uses, including the placement of hazardous materials.
- » Coordinate maintenance contract with local property owners or local authorities to ensure regular pick-up.

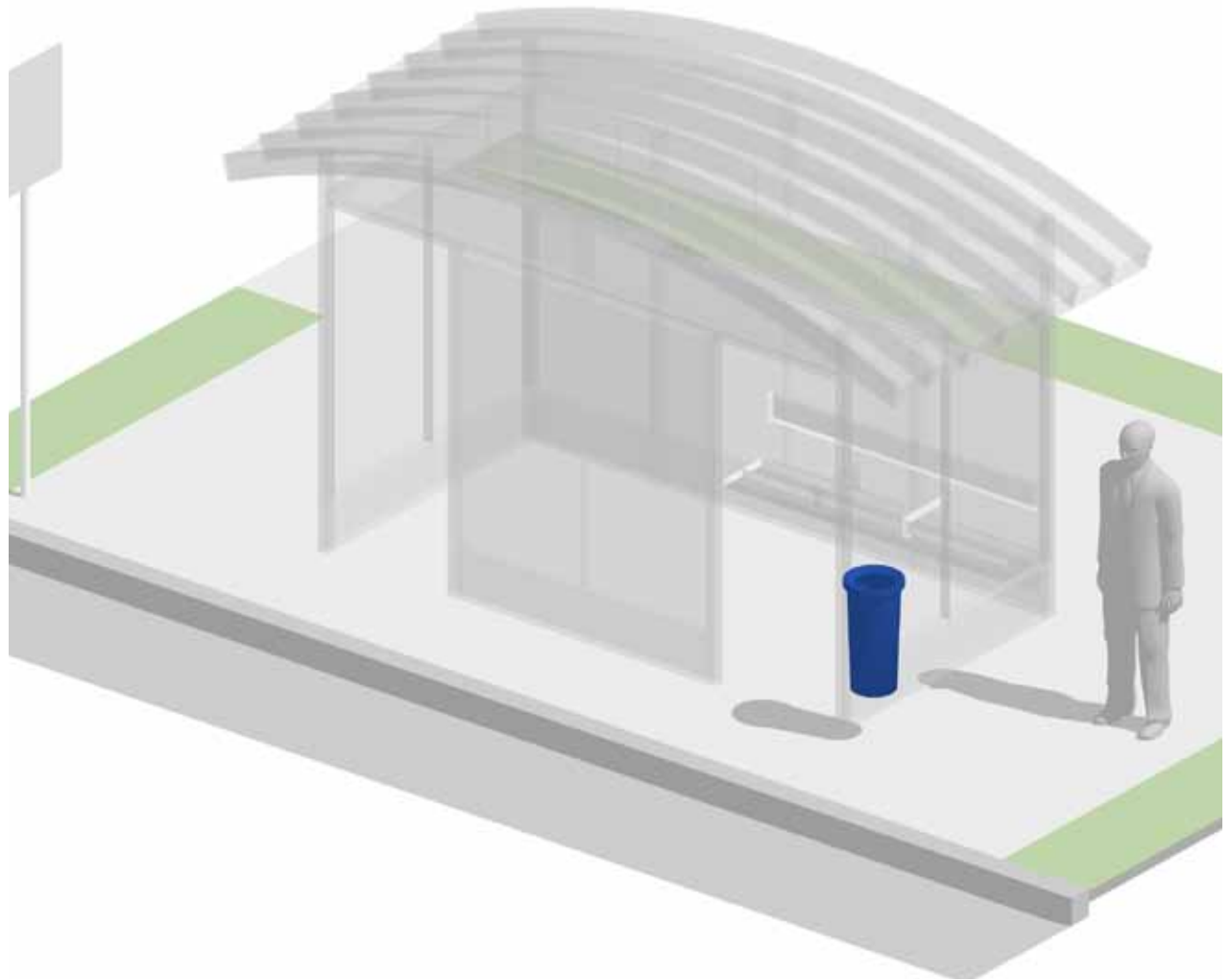

LIGHTING

Adequate lighting should be provided at bus stops and waiting areas for passengers. Lighting features are integral components of Crime Prevention Through Environmental Design (CPTED) methods, and adequate lighting will allow transit vehicle drivers to clearly see the bus stop area and identify waiting passengers and possible obstructions in the bus stop zone. For communities that participate in Pace's Ad Shelter Program, shelter lighting will be provided by Pace.

The placement of freestanding municipal lighting fixtures is recommended by Pace. Local municipalities establish lighting standards for their jurisdictions. Lighting plans for bus stop areas as well as those for the entire development must be coordinated with appropriate municipalities. The following should be considered when determining the lighting needs at bus stops:

- » Provide adequate vertical clearance for all lighting fixtures based on manufacturers specifications.
- » Lighting poles and fixtures should meet all clear zone requirements.
- » Lighting should provide a minimum illumination level of 2 horizontal foot-candles over the entire bus stop area.
- » Lights should be shielded so as not to interfere with motorists.
- » The hours of illumination should correspond with the anticipated hours of use for the stop.

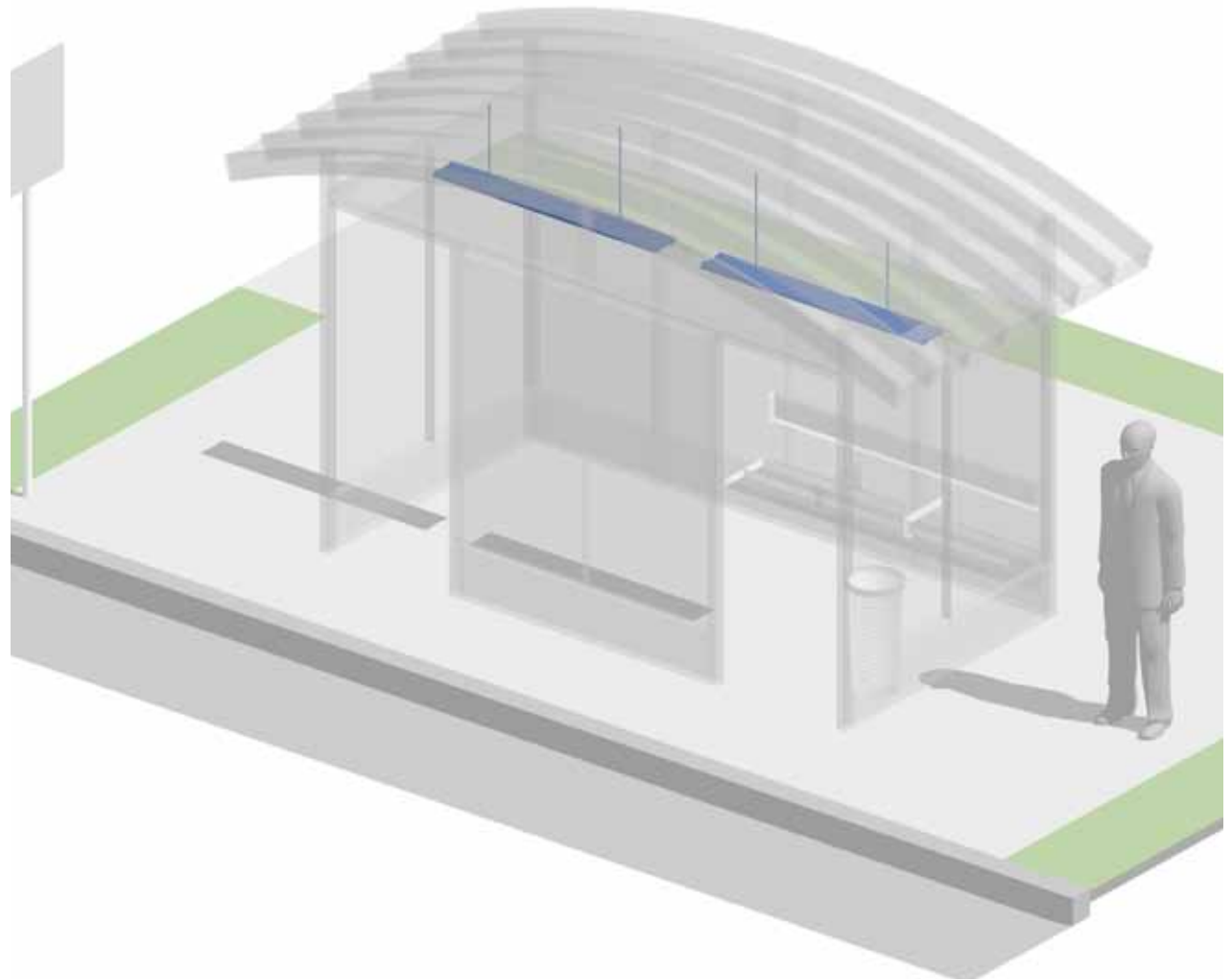

ADDITIONAL STOP AMENITIES

LANDSCAPING

Landscaping can be used at transit waiting areas to increase passenger comfort and local aesthetics. Earth berming, trees, plantings, decorative fences and colored or embossed paving materials all help to create an aesthetically pleasing and inviting pedestrian environment. Landscaping can also serve as a crime deterrent as described by CPTED methods by generating a sense of pride and ownership, and indicating frequent pedestrian activity. Care should be taken to maintain pedestrian and driver sight distances with all landscaping features to prevent safety hazards.

The following should be considered when adding landscaping features to bus stop areas:

- » Shrubs should maintain a low maximum height, and the lowest branches of trees should be high enough, to ensure that visibility at eye level for vehicle operators and pedestrians is unimpaired.
- » Native trees and plants with minimum maintenance requirements should be used.
- » Trees should be positioned to provide maximum shade for benches and waiting areas.
- » Plants should not block views of accessways.
- » Plant relocation and selective thinning or clearing should be used to preserve natural landscape features.



BICYCLE RACKS

Bicycle racks and storage can be provided near bus stop locations to encourage bicycle use to and from transit. Stationary racks that provide stable support for bicycles or enclosed bicycle lockers with locking doors can be installed for storage purposes.

Weather protection and security from theft and vandalism should be considered when selecting the bicycle storage device and to determine its location. The facility should be located in a well-lit area that has a high degree of visibility. If possible, a monitored location should be used.

Any bicycle storage facility within a bus stop area should have the following attributes:

- » Minimum clearance distance from the nearest object to ensure easy circulation and access to bicycles and other amenities.
- » Clearly visible from surrounding areas.
- » Located at the periphery of the bus stop area.
- » Securely mounted on the ground.
- » Preferably located at the upstream end of the stop area, away from the landing pad.
- » Preferably shielded from rain.
- » Preferably in a well-lit area.



Bicycle racks help foster the interface between bus transit and other means of personal mobility.

CONVENIENCE AMENITIES

Additional convenience amenities can be provided at transit stops to reduce the number of trips a pedestrian must make to obtain convenience items and increase the appeal of the transit stop location. Automatic teller machines (ATMs), vending machines, and newspaper vending boxes are a few of the items that will enhance passenger waiting areas. Care should be taken to integrate these amenities to minimize visual and physical clutter at the stop and to avoid obstructions to the corner sight-line.

Transit facilities can incorporate small services, retail, or rider amenities that enhance the transit experience.



BUS STOP INFORMATION & TECHNOLOGIES

TRANSIT INFORMATION

Transit route information can be displayed on shelters, in business lobbies, along development walkways and in other appropriate areas to provide accurate route and schedule information to the public. Bus stop designs should accommodate signage areas installed and maintained by Pace that can adequately house local and regional route information. Additional wayfinding information is often helpful as well, such as a map of the local area with points of interest. However, the structures that host this information should not conflict with transit information signage. Depending on sign location and type, approval from local municipalities, IDOT or Pace may be required.

Real-time passenger information can be displayed on variable message signs (VMS), providing passengers with the knowledge that they are receiving reliable, up-to-date information. Information related to vehicle arrival times may help instill rider confidence and comfort and can contribute to overall travel time competitiveness by allowing passengers to run short errands when time allows. Destination and transfer information at bus terminals may also increase the overall usability of the system.



According to IDOT standards, all signs and mounted objects should meet the following criteria (Bureau of Local Roads and Streets Manual, Special Design Elements, IDOT, pg. 41-6(8), 2008):

iii

- » Objects projecting from walls (e.g., signs, telephones, canopies) with their leading edges between 27 inches and 80 inches above the finished sidewalk shall not protrude more than 4 inches into any portion of the sidewalk.
- » Freestanding objects mounted on posts or pylons may overhang their mountings up to a maximum of 12 inches when located between 27 inches and 80 inches above the sidewalk or ground surface.

- » Protruding objects less than 27 inches or greater than 80 inches may protrude any amount provided that the minimum clear width of the sidewalk is maintained.
- » Where the vertical clearance is less than 80 inches, provide a barrier to warn the blind or visually impaired person.

X see references (page iii)

INTELLIGENT TRANSPORTATION SYSTEM (ITS) APPLICATIONS

ITS applications require both power and communication infrastructure, but have the potential to significantly improve the usability of transit as well as the overall feeling of safety and security. Potential ITS applications include:

- » Real-time arrival information
- » Electronic schedules and route information
- » Interactive information displays
- » Payment and smart card payment kiosks
- » Audible signage
- » Wireless connectivity for arrival and scheduling information
- » Cameras and emergency call stations
- » Electronic driver-to-waiting passenger communication

Pace would take responsibility for the installation of most ITS applications, but care should be taken to ensure the presence of power and communication connections for such devices.



ITS applications enhance rider experience by providing real-time information that results in more predictable service.

PASSENGER WAITING AREAS IMPLEMENTATION CHECKLIST

Guideline Principles	Implementation Tools
Address bus stop accessibility for all users early in the decision making process for all bus stop plans	Local zoning and subdivision regulations, Local public works/ engineering standards, D.O.T standards
Coordinate with Pace to design bus stop locations with amenities to provide a comfortable, safe, and convenient waiting area for transit users	Local public works/engineering standards
Coordinate with Pace to provide passenger shelters for bus stop areas that are high volume boarding sites	Local public works/engineering standards
Coordinate with Pace to integrate transit route information, local wayfinding, and/or Intelligent Transportation Systems (ITS) to provide accurate route and schedule information to the public.	Local public works/engineering standards, D.O.T standards

Chapter 5

Guidelines for the Public Realm

This section of the Guidelines describes design and development principles that relate to the components of the transit trip that occur in the public right-of-way once out of the Pace transit stop facility. The application of specific standards may be implemented through subdivision and zoning regulations and public works standards.

STREET NETWORK DESIGN	87
CREATING SAFE AND COMFORTABLE SIDEWALKS	97
MANAGING SHARED PEDESTRIAN/VEHICULAR SPACES	103

Section 5a

Street Network Design

The overall pattern of streets and their specific designs should promote walkability and access between areas of living, work, commercial activity, and recreation. This implies the utilization of a roadway pattern that provides a reasonably direct route as well as amenities that provide safe choices for vehicles, bicyclists and pedestrians.

GRID CONNECTIVITY	88
BLOCK SIZE	89
RIGHT-OF-WAY WIDTH	90
MULTI-MODAL NETWORKS	94
INFRASTRUCTURE DESIGN PRINCIPLES	95

GRID CONNECTIVITY

A well-connected grid pattern supports walkability by providing direct routes from several origin points. Street patterns should be designed to maximize network connections and avoid “dead end” segments that result in circuitous paths.

Link-node ratio is a measurement frequently used to quantify the connectivity of a street grid. It measures the ratio of links (street segments) to nodes (intersections or dead ends). Areas with bus transit service should strive to enhance connectivity by providing as many links as possible between network nodes, and therefore, a higher link-node ratio.

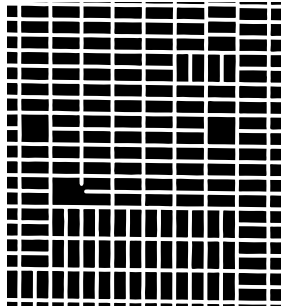

Traditional urban grid



Highly-Supportive
Link-node ratio: 1.65
The traditional urban grid provides a high level of connectivity between various land uses and public transit centers and corridors.

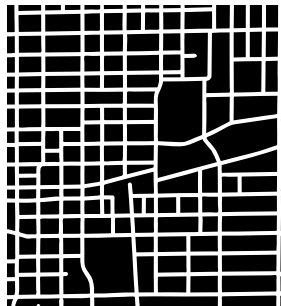

Traditional suburban grid



Moderately-Supportive
Link-node ratio: 1.55
The traditional suburban grid maintains a fairly high level of connectivity, but larger blocks disrupt the grid and create occasional barriers to transit centers.

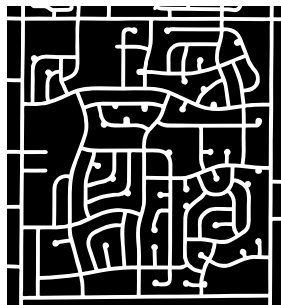

Contemporary suburban or rural grid



Non-Supportive
Link-node ratio: 1.15
Contemporary or rural grid patterns tend to limit access to transit centers by creating dead ends or extremely large blocks that require greater walking distances.

BLOCK SIZE

Access to transit is often impacted by the size of blocks. Large blocks limit opportunities for direct walking routes and create large segments of roadway that can be difficult to cross for pedestrians. The Chicago region's traditional block dimensions are approximately 600' long and 300' wide, though blocks are often 300' by 300' in downtown areas. Though standard block size varies by community, block sizes in areas served by transit should not exceed 600' in length, and should be between 300' and 350' in downtown areas.

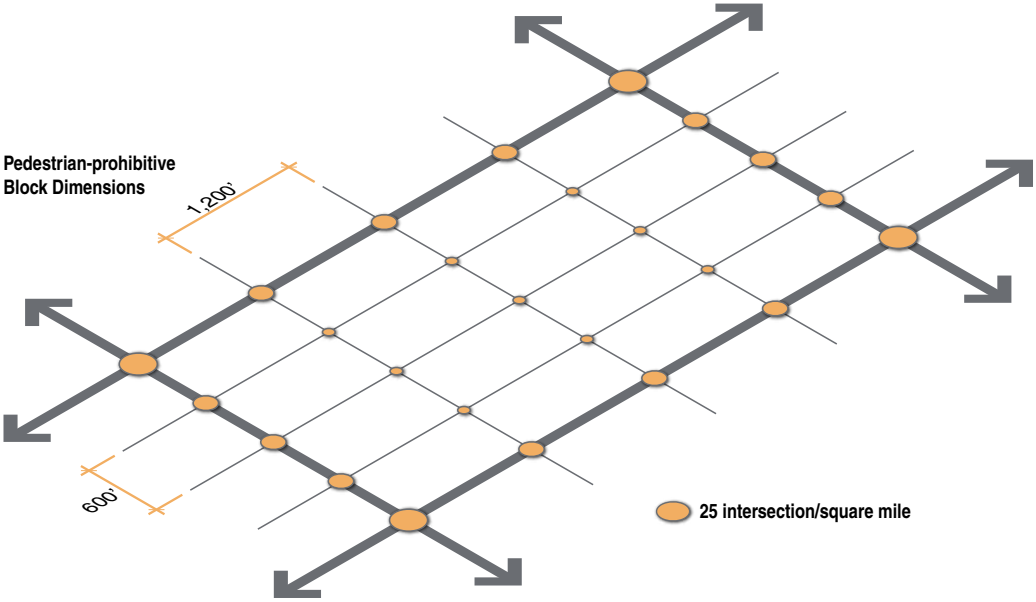
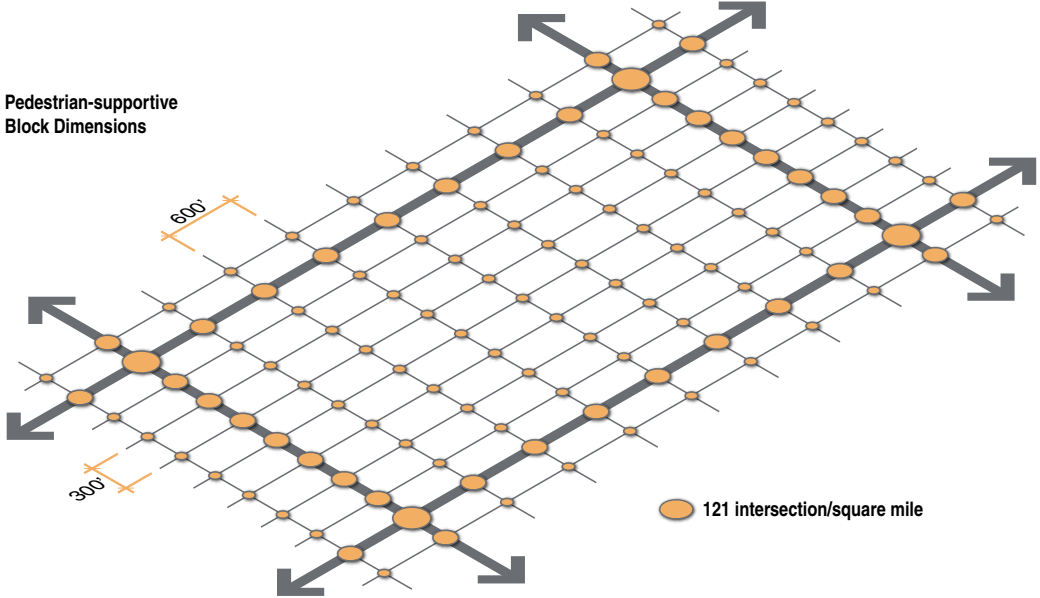

RIGHT-OF-WAY WIDTH

The size of the right-of-way has direct impacts on transit access in terms of what types of vehicles and infrastructure can be accommodated, what kind of service may operate, and to what extent it inhibits pedestrian access to the service and facilities. The widths of rights-of-way vary greatly throughout the region based on the classification and jurisdiction of a specific roadway, as well as the context within which it operates. Currently, rights-of-way for major suburban arterials tend to be between 100-150' and typically have expansive parkway strips along each curb, while more traditional commercial streets are approximately 75-90'. Existing local streets may have rights-of-way from 60-75'. Transit-supportive rights-of-way should provide the space necessary for vehicular, bicycle and pedestrian operations, yet minimize unnecessary elements that create additional space and barriers between local activities and transit services.

The following pages describe transit supportive rights-of-way for various roadway configurations.



60'-75' ROW includes urban commercial streets and suburban local streets



75'-100' ROW includes many suburban downtowns and suburban/rural collector streets



100'+ ROW includes most suburban arterials or high-speed suburban/rural regional roadways

60' RIGHT-OF-WAY

a-b Streets with a 60'-75' right-of-way are typically local streets that host residential or community-based commercial activities. Generally, these streets should aim to provide local multi-modal access to goods and services. Transit, bicycle and pedestrian circulation should be a high priority.

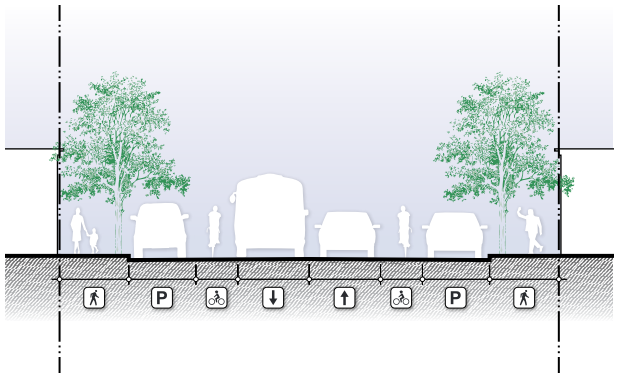

Multi-modal access
The cross-section should balance local priorities related to dedicated bicycle facilities and adequate pedestrian areas

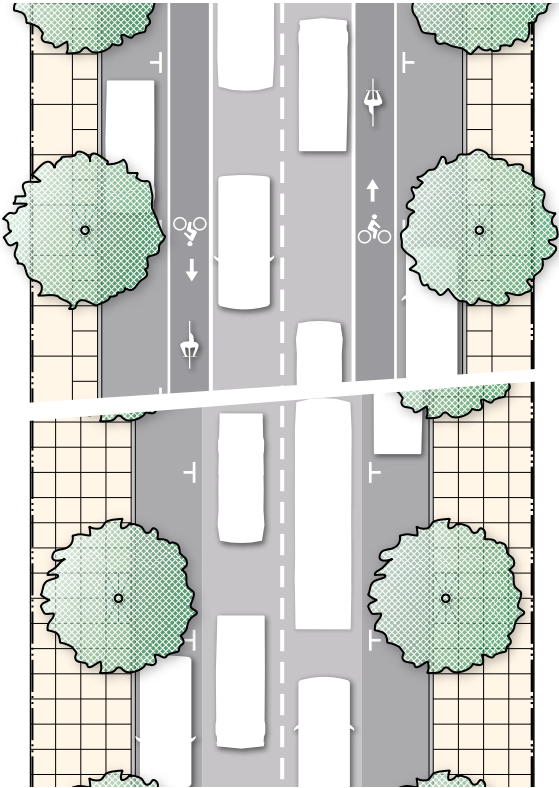

Bike lane alternative
Dedicated bike lanes provide efficient multi-modal mobility along the corridor

Pedestrian alternative
Expanded sidewalks provide space for sidewalk amenities that complement areas of more intensive pedestrian activity

Cross-Section Element	Minimum	Maximum
Sidewalk and Parkway	8.5'	10-12'
On-street Parking	8'	11' (when no dedicated bike lane is provided)
Bike Lane	6', if provided	8', if other transit supportive amenities have been maximized
Travel Lane	9'	10'

Source of dimensions from Institute of Transportation Engineers (ITE)

X see the Technical Appendix

75' RIGHT-OF-WAY

a-b Streets with a 75'-90' right-of-way are typically collectors or minor arterials. They typically provide access between communities and may host limited residential uses with a greater prominence of retail or small office activities. Vehicular, transit, bicycle and pedestrian mobility should be equally prioritized, with urban design being maximized to ensure clear delineations between various transportation facilities. Depending on roadway width, parking configurations and traffic operations, medians can provide a unique character and safe haven for pedestrians.

Cross-Section Element	Minimum	Maximum
Sidewalk and Parkway	8.5'	20'
On-street Parking	8'	11' (when no dedicated bike lane is provided)
Bike Lane	6', if provided	8', if other transit supportive amenities have been maximized
Travel Lane	10'	11'
Landscaped Median	8'	16', if other transit supportive amenities have been maximized

Source of dimensions from Institute of Transportation Engineers (ITE)

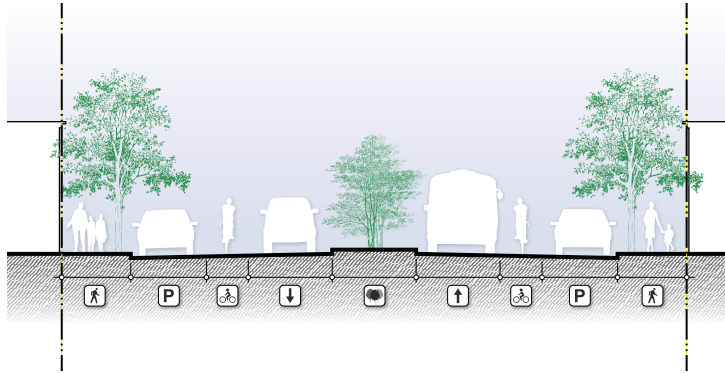

Balancing vehicular and transit mobility

The cross-section should be designed to balance vehicular efficiency and transit and pedestrian safety

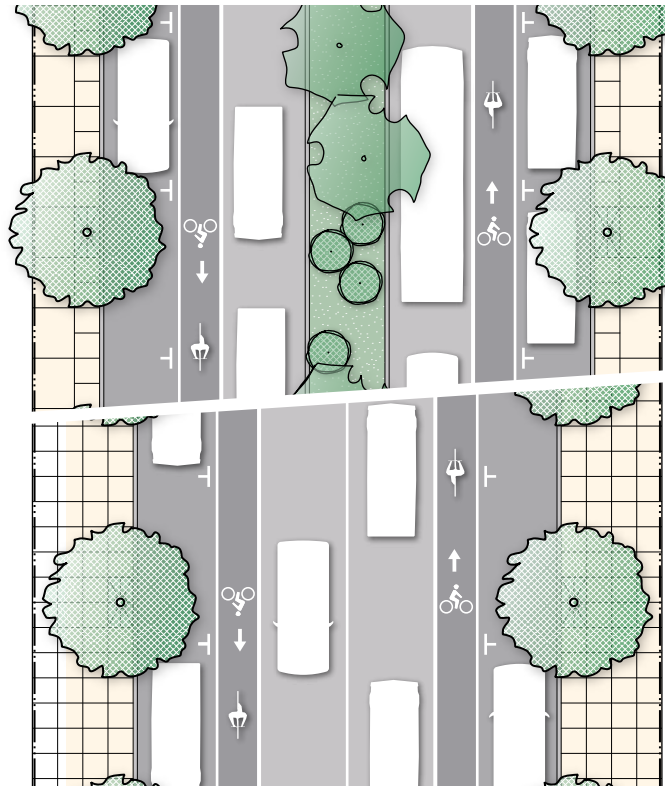

Landscaped median alternative

A landscaped median provides an attractive element that breaks up the length of pedestrian crossings

Commercial sidewalk alternative

The width for the sidewalk can be maximized to accommodate sidewalk amenities and heavy pedestrian volumes associated with local commercial activity

X see the Technical Appendix

100' RIGHT-OF-WAY

a-b Streets with right-of-way of 90' or more are typically major arterials. They tend to provide higher-speed mobility to other parts of the region, and typically host large-scale commercial and retail uses. Major arterials generally consider vehicular mobility as the main priority. However, the right-of-way can often accommodate infrastructure that effectively integrates transit, bicycle and pedestrian mobility. Medians, pedestrian refuge areas, buffers, dedicated paths and other urban design elements should be used at strategic locations to create comfortable multi-modal conditions and an attractive corridor character.

Cross-Section Element	Minimum	Maximum
Sidewalk and Parkway	8.5'	20'
On-street Parking	8'	11' (when no dedicated bike lane is provided)
Bike Lane	6', if provided	8', if other transit supportive amenities have been maximized
Travel Lane	10'	11'
Landscaped Median	8'	16', if other transit supportive amenities have been maximized

Source of dimensions from Institute of Transportation Engineers (ITE)

X see the Technical Appendix

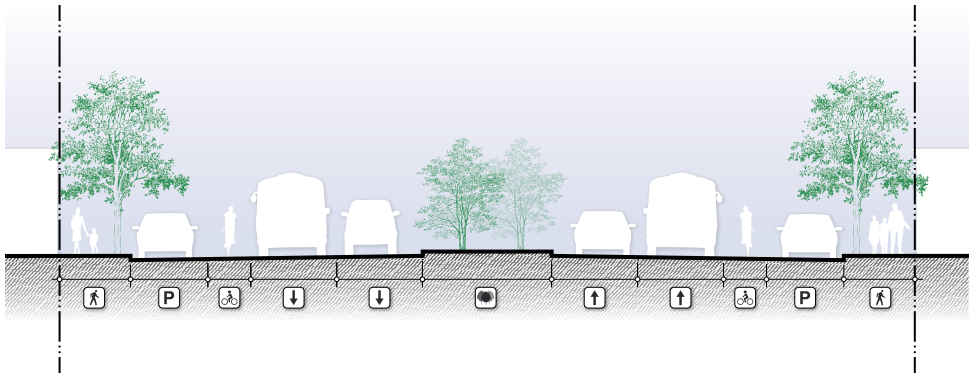

Pedestrian safety and comfort
 On streets primarily designed for vehicular movement, infrastructure and design elements must be used to maximize access to transit and surrounding uses

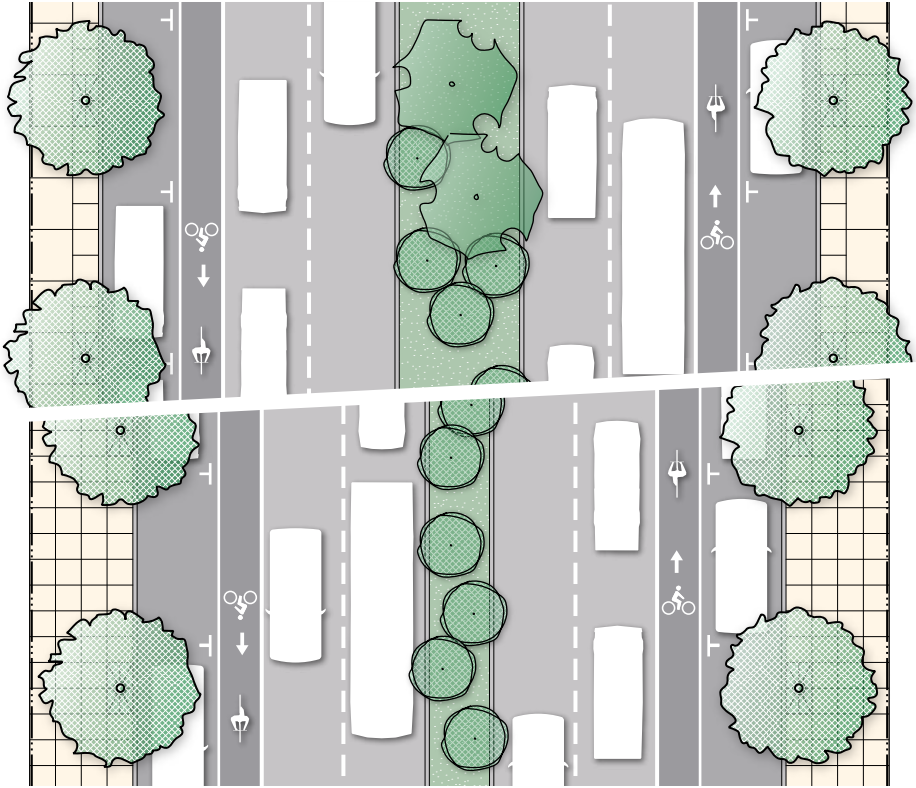

Expanded median alternative
 An expanded median provides a refuge area at crosswalks and enhances the character of highly traveled corridors

Expanded sidewalk alternative
 Wide rights-of-way can accommodate comprehensive transit supportive infrastructure including wide sidewalks that provide additional buffering between pedestrians and vehicular traffic flow

MULTI-MODAL NETWORKS

Streets should safely accommodate all modes of travel. All rights-of-way should have sidewalks on both sides of the street. Streets should be designed to accommodate safe bicycle use, especially on corridors that are identified as local or regional bike corridors. In this case, special efforts should be made to accommodate dedicated bike lanes.



Urban streets and suburban downtowns should accommodate several modes of access, including on-street parking, bike lanes and strong pedestrian networks



Suburban corridors and rural roadways should foster bicycle and pedestrian mobility that is safely integrated with high-speed vehicular traffic flow

INFRASTRUCTURE DESIGN PRINCIPLES

Often, design specifications oriented toward vehicular movements compromise the integrity of local access to transit. To the extent possible, the following principles should be followed in areas where transit service is provided.

- » The width of traffic lanes should be limited to the minimum allowable standard. This will reduce pedestrian crossing distances and potentially slow traffic to mitigate the risk of accidents.
- » Curb radii should be kept to the minimum allowable standard. Wherever feasible, mountable curbs should be used to accommodate truck turning movements. This will reduce crossing distances for pedestrians when trucks are not present.
- » The design and installation of infrastructure and pedestrian amenities should be closely coordinated. Often, the expansion or replacement of infrastructure results in a compromised sidewalk network. Such improvements should be performed in such a way that a fully accessible sidewalk network is maintained.



STREET NETWORK DESIGN IMPLEMENTATION CHECKLIST

Guideline Principles	Implementation Tools
Design a well-connected grid pattern of streets that maximizes network connections.	Local zoning regulations, local subdivision regulations
Plan small block sizes.	Local subdivision regulations
Maximize multi-modal infrastructure within existing right-of-way.	Local subdivision regulations, local public works/engineering standards
Limit traffic lanes widths to the minimum allowable standard in order to accommodate bike lanes, adequate sidewalk width, etc.	Local subdivision regulations, local public works/engineering standards, D.O.T standards
Keep curb radii to the minimum allowable standard in order to minimize pedestrian crossing distances.	Local public works/engineering standards, D.O.T standards
Coordinate the design and installation of infrastructure and pedestrian amenities.	Local subdivision regulations, local public works/engineering standards, D.O.T standards

Section 5b

Creating Safe and Comfortable Sidewalks

Simply providing sidewalks is often inadequate in areas where transit is a critical aspect of local mobility. In order to remove barriers to transit use, the pedestrian environment must be carefully designed to provide buffering from vehicular traffic and accommodate a variety of users.

LANDSCAPE ZONE	98
PEDESTRIAN ZONE	99
ON-STREET PARKING	100
TRANSIT ACCESS	101

LANDSCAPE ZONE

The landscape zone includes the portion of the right-of-way between the sidewalk and the curb. It may consist of a planted parkway or hardscaped furniture zone, depending on surrounding uses and the type of character being sought. The landscape zone should be a minimum of 5', and may be wider in order to accommodate streetscape elements, furniture, or sidewalk uses (i.e. café seating or outdoor displays.) This zone should be used to accommodate planters, lighting, historic or informational signage, gateways, benches, bicycle racks, trash receptacles, trees, utility boxes, parking meters, etc.





PEDESTRIAN ZONE

The pedestrian zone is the primary area of movement on the sidewalk. It should be a minimum of 5' wide. In downtown areas, or in other areas of intensive pedestrian activity, the pedestrian zone should be 8-10' wide. It should use materials that are smooth and contain no significant variations in height, and should meet the requirements of the Americans with Disabilities Act in terms of texture, clearance and maintenance.

ON-STREET PARKING

Areas of significant transit activity often benefit from on-street parking that serve nearby uses. On-street parking also provides a buffer between the roadway and public sidewalk. This form of parking should be encouraged on prominent transit corridors and should be configured to safely accommodate bus transit stops. Parking spaces are typically either parallel or diagonal. Diagonal spaces typically include tire stops or some other physical barrier to ensure vehicles do not encroach upon the landscape or pedestrian zones.

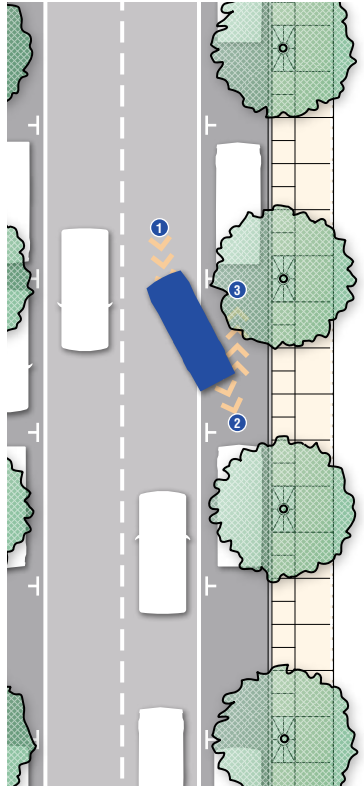

Parallel Parking

Parallel parking minimizes the cross-section dimension required for on-street parking and supports local commercial activities

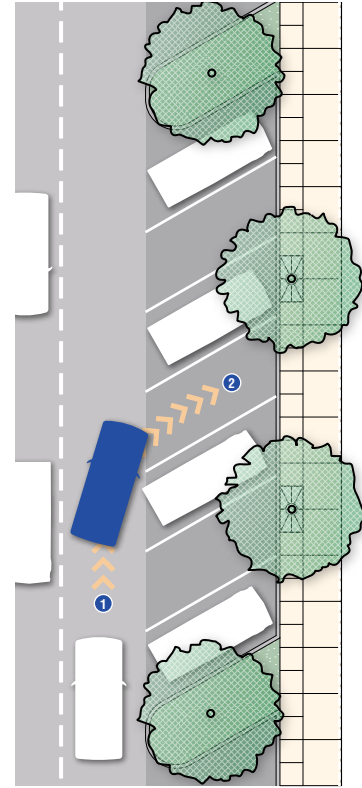

Diagonal Parking

Diagonal parking increases the number of on-street spaces and provides a substantial buffer between the sidewalk and vehicular traffic flow

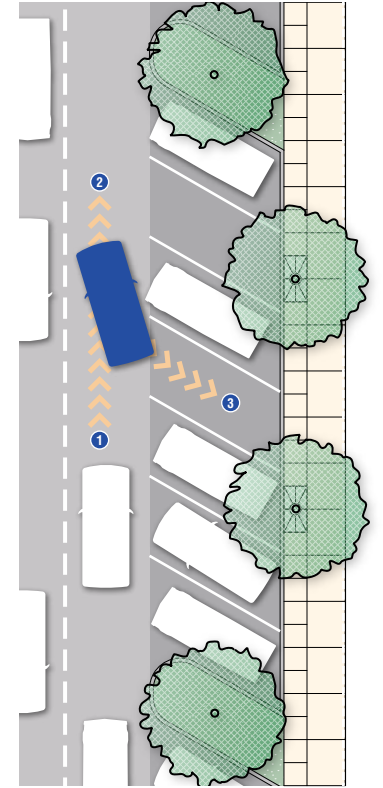

Reverse-Diagonal Parking

Reverse-diagonal parking enhances the safety of parking movements by increasing visibility and entry into traffic flow when exiting the space

TRANSIT ACCESS

The public sidewalk should fully connect designated transit stops. When necessary, segments between the sidewalk and shelter pad should be provided. Accessibility for all people is important for sidewalk design.

Additional space should be provided in order to safely accommodate transit stop amenities, such as trash receptacles, bike racks, newspaper boxes, etc. that are above and beyond standard transit stop amenities provided by Pace.



CREATING SAFE AND COMFORTABLE SIDEWALKS IMPLEMENTATION CHECKLIST

Guideline Principles	Implementation Tools
Provide adequate width on public sidewalks and landscape areas in order to accommodate curbside amenities that enhance the pedestrian environment.	Local subdivision regulations, local public works/engineering standards, D.O.T standards
Provide on-street parking, and coordinate its design with transit operations and stop locations.	Local public works/engineering standards, D.O.T standards
Connect transit stops to the sidewalk network.	Local subdivision regulations, local public works/engineering standards, D.O.T standards

Section 5c

Managing Shared Pedestrian/ Vehicular Spaces

Functional urban streets typically include areas where vehicles and pedestrians must directly interact. For such streets to be transit supportive, a variety of tools can be used to manage traffic flow, provide information to both motorists and pedestrians, and create comfortable spaces. The following should be considered for any streets where pedestrians must navigate areas of vehicular circulation or traffic flow.

TRAFFIC CALMING	104
SIGNAGE AND INFORMATION	105
PEDESTRIAN COMFORT	106

TRAFFIC CALMING

Managing the speed of traffic flow is an important consideration in creating a quality pedestrian environment. Municipalities and agencies should consider the design of the roadway and its supporting components for fostering safe and efficient vehicular operations. On Pace transit routes, traffic-calming techniques should be weighed against the transit vehicle's ability to navigate traffic and maintain efficient service speeds.

- » Varying lane widths and meandering roadway geometries force motorists to slow down and be more aware of the street environment.
- » Textured roadway materials call attention to unique areas through a different feel and sound as motorists drive through.
- » Speed tables, or speed bumps with crosswalks at the grade of the surrounding sidewalk network, provide at-grade pedestrian crossings that require slow vehicle speeds and increase visibility for both pedestrians and motorists.
- » On-street parking slows traffic through the inherent actions of parking vehicles and opening car doors.

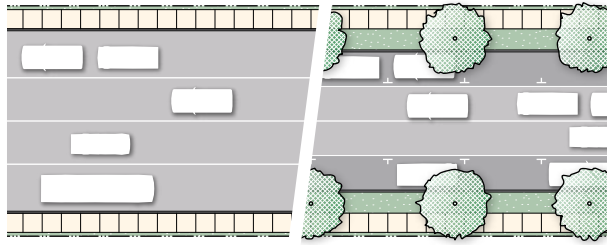

Road Diet

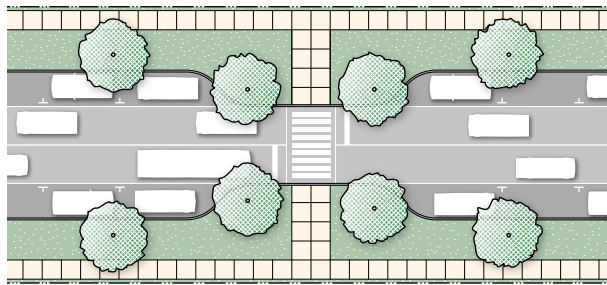

Midblock Bulbout

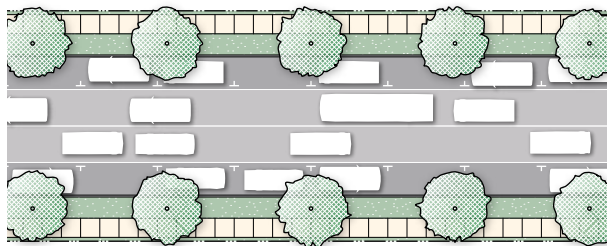

On-street Parking Both Sides

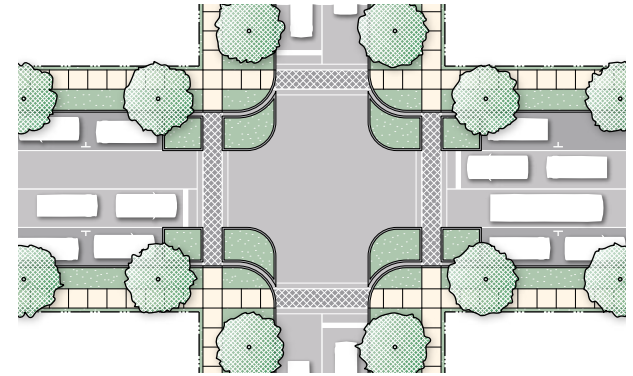

Intersection Bumpouts

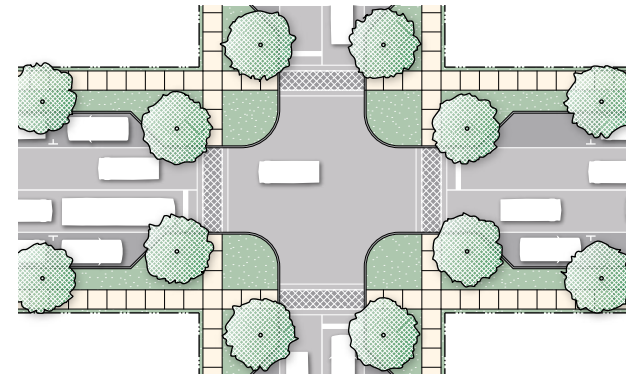

Intersection Bulbout

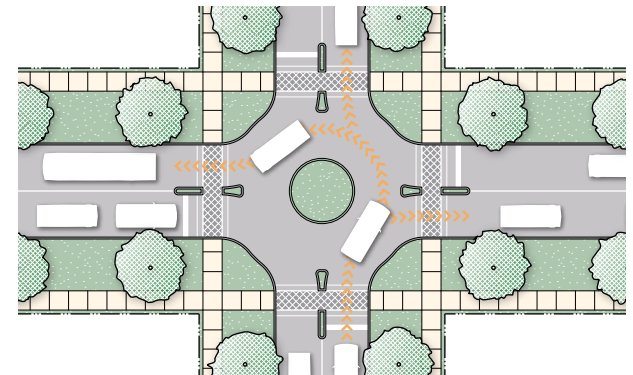

Intersection Roundabout

SIGNAGE AND INFORMATION

Information is critical to safe vehicular operation and pedestrian movement. Transit supportive streets should provide clear information for both motorists and pedestrians. The following techniques are available to municipalities and agencies.

- » Pedestrian crossing signals should be installed at every signalized intersection. At a minimum, pedestrian signals should include “Walk” and “Don’t Walk” lights, but should also include countdown timers, especially on roadways with wide crossing distances .
- » Curbside or median pedestrian signs can be used to call attention to crossing locations and slow vehicular traffic.
- » Pedestrian crosswalk warning systems including highly-visible signage and flashing lights in the roadway that alert motorists to the presence of pedestrians. The lights are generally triggered by a crossing button activated from the public sidewalk. These systems are most effective at mid-block crossings, or at any crossing that lacks traffic signals or stop signs but may be a popular location for pedestrian crossing.
- » Crosswalk painting designs vary based on municipality and context. Designs should be chosen based on visibility to oncoming motorists. Single parallel lines tend to be difficult to see for motorists. However, “cross-hatch” or “ladder” patterns are more visible for motorists.

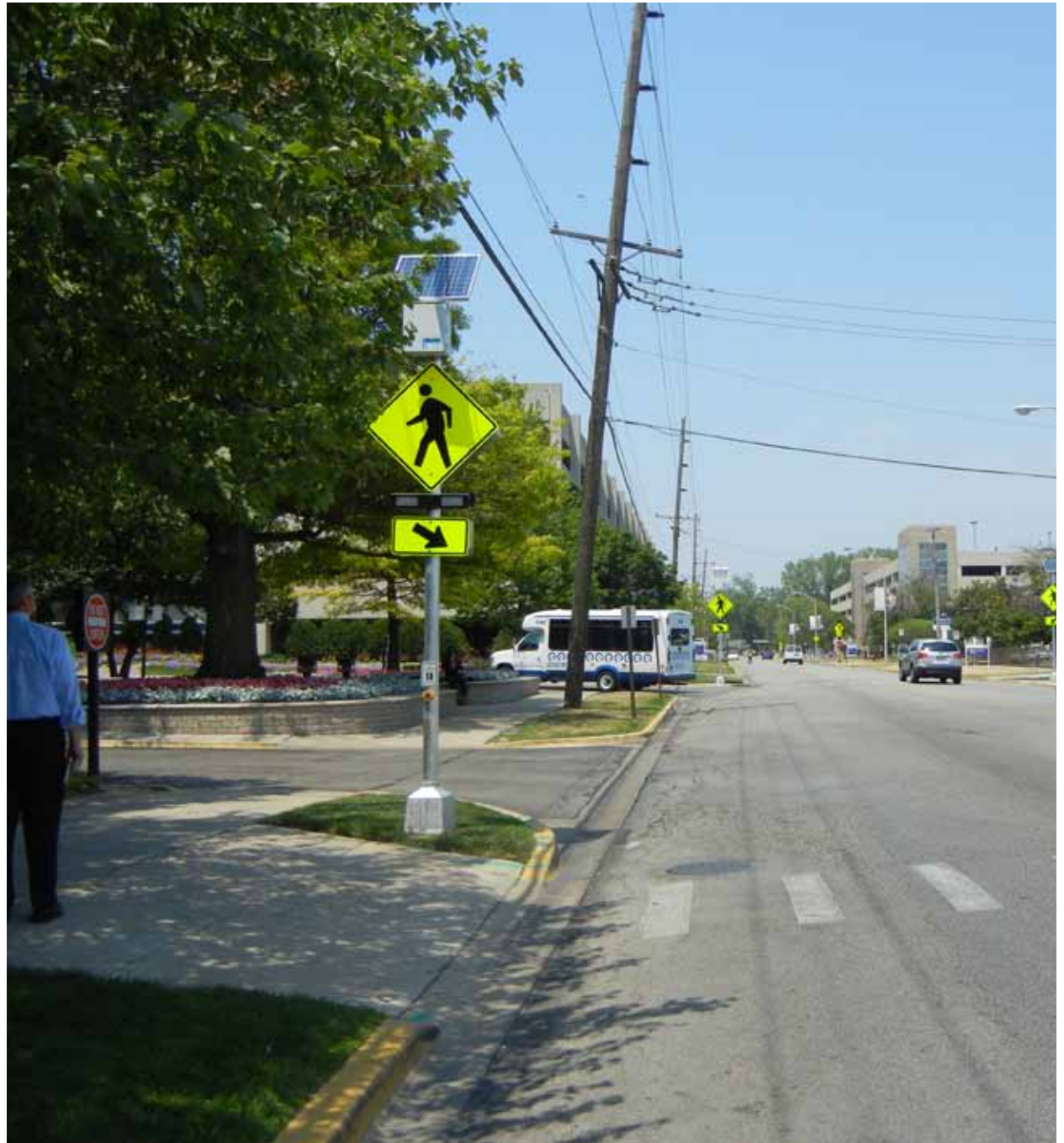

PEDESTRIAN COMFORT

Comfort, in addition to functionality and safety, is an important consideration in a transit supportive environment. The design of the public realm can create a more comfortable environment by reducing the areas shared by pedestrians and motorists, creating better buffers between vehicular and pedestrian areas, or providing more attractive urban spaces. The following tools should be considered in transit supportive areas, though impacts on transit operations should be carefully considered when these improvements are applied on corridors served by transit:

- » Landscape zone between sidewalks and vehicular traffic
- » On-street parking
- » Hardscape elements and street furniture
- » Sidewalk bulb-outs that reduce crossing distances



Sidewalk Bulb-outs

Bulb-outs create a physical buffer between pedestrians and vehicles and shorten the crossing distance at intersections



Pedestrian Comfort

Landscaping, lighting and decorative pavers clearly delineate the public sidewalk from the roadway.

MANAGING SHARED PEDESTRIAN/ VEHICULAR SPACES IMPLEMENTATION CHECKLIST

Guideline Principles	Implementation Tools
Traffic Calming	
Use lane widths and geometries to reduce traffic speeds and enhance pedestrian safety where it can be done without compromising transit operations or on-time performance.	Local public works/engineering standards, D.O.T standards
Use textured roadway materials or visible striping to call motorist's attention to unique areas.	Local public works/engineering standards, D.O.T standards
Install speed tables in at-grade pedestrian crossings that require slow vehicle speeds and increase pedestrian visibility.	Local public works/engineering standards, D.O.T standards
Plan on-street parking, which slows traffic through the inherent actions of parking vehicles and opening car doors.	Local public works/engineering standards, D.O.T standards
Signage and Information	
Install pedestrian crossing signals at every signalized intersection, especially those with high levels of pedestrian activity.	Local public works/engineering standards, D.O.T standards
Install pedestrian crossing warning systems where appropriate.	Local public works/engineering standards, D.O.T standards
Use highly visible pedestrian crosswalk painting design.	Local public works/engineering standards, D.O.T standards
Pedestrian Comfort	
Utilize curb bump-outs, pedestrian refuge islands, and clearly delineated crosswalks.	Local public works/engineering standards, D.O.T standards

Chapter 6

Guidelines for the Private Realm

This section of the Guidelines describes design and development principles that relate to the components of the transit trip that occur on private lots or property, including publicly held properties that are not considered part of the public right-of-way (i.e. parks or institutional sites). The application of specific standards are frequently implemented through subdivision and zoning regulations, but may be influenced by the standards of other agencies who hold jurisdiction over adjacent rights-of-way.

**TRANSIT-SUPPORTIVE
LAND USE 111**

**SITE
DESIGN 117**

**PARKING & ACCESS
MANAGEMENT 121**

**BUILDING
DESIGN 127**

**ON-SITE TRANSIT
FACILITIES 131**

Section 6a

Transit-Supportive Land Use

Land use and transit are inherently linked. Active land uses foster more effective transit service, and transit mobility makes locations more viable for development. These guidelines recognize that market viability for specific uses, or levels of development intensity, vary across Chicagoland, as does the local tolerance for density. However, the following represent principles for land use and development intensity that, if appropriately implemented, would enhance transit performance and potentially justify increased levels of transit service.

**LOCAL
LAND USE 112**

**TRANSIT-SUPPORTIVE
MIXED-USE 113**

**DEVELOPMENT
DENSITY 114**

LOCAL LAND USE

Transit service is most effective when coupled with specific types of local land uses. To provide mutual benefit for local transit users, business owners and Pace, municipalities should seek land uses that contain the following characteristics:

- » Preferred uses have a high population ratio compared to the size of the spaces they occupy. For example, manufacturing facilities tend to require large footprints but employ few people. This is a missed opportunity close to transit service. Instead, communities should target office, service, or residential uses that place more people closer to transit stops.
- » Preferred uses create consistent foot traffic and high levels of activity. Successful transit environments tend to support shopping, services, restaurants and other uses that generate frequent pedestrian traffic and spin-off investment. For example, quality retail draws people to local restaurants, and vice versa.
- » A preferred mix of uses creates activities at various times of the day. For example, office activity and some commercial services with regular office hours provide activity during weekdays. Residential and entertainment uses provide activity during evenings and weekends. Restaurants can then thrive since they are not relying on one service rush each day. Though it is unlikely to find a single type of use that generates activity throughout the day or week, the appropriate mix of uses can do so effectively.
- » Preferred uses align with the behaviors and patterns of transit riders. For example, large grocery stores are a necessary community-based land use, but transit supportive development must assume that many of their customers are walking home after shopping. Transit-based shoppers do not buy groceries for the week since they cannot carry them home. They may shop more frequently and buy less on each trip. The types of uses and formats of stores should be tailored to transit rider behaviors and preferences.
- » Preferred uses are not dependent on large areas of parking. Parking not only increases potential conflicts between motorists and pedestrians, but it also takes up significant pieces of land that could better support transit through active uses.

The following list includes a sample of transit supportive land uses. Other uses not on this list should be considered, assuming they meet the goals of local land use and transit supportive development:

RESIDENTIAL

- Small lot single-family (<6,000 s.f. lots)
- Townhouses
- Multi-family buildings

RETAIL

- Small grocers
- Pharmacies
- Hardware stores
- Basic goods
- Clothing and fashion
- Home goods (delivery-based)

SERVICE

- Medical/dental offices
- Banking
- Small professional services (i.e. architects, lawyers)
- Dry cleaning
- Daycare

EMPLOYMENT

- Staff-intensive offices (i.e. customer service centers)

TRANSIT-SUPPORTIVE MIXED-USE

Mixed-use development is often used to attain the balance of activities that help create a transit supportive environment. Mixed-use development should be encouraged around transit corridors and nodes. Development should be configured to accommodate a variety of the uses described in the Local Land Use section above. Structures should also be designed to be flexible over time to respond to evolving markets. For example, a building with ground-floor retail may have upper story space that could serve as either office or residential based on the overall building footprint, access, and structural grid. Over time, space could change to maintain occupancy and market viability, which in turn helps sustain activities near transit.



DEVELOPMENT DENSITY

Increasing the level of density around transit service makes the service more viable and effective since there are more potential users and destinations in a smaller geographic area. However, attitudes toward density vary throughout the Chicago region. Municipalities should consider opportunities to increase development density around existing or planned transit services in such a way that development meets the goals of both enhanced access to transit and the preservation of community character.

The map to the right illustrates places in the Chicago region that have transit supportive residential densities based on the assumption that seven (7) dwelling units per acre are required to support basic bus transit service (source: APTA).

The images on the accompanying page illustrate regional examples of various transit supportive development densities and demonstrate how they are an integral piece in defining a positive local character.

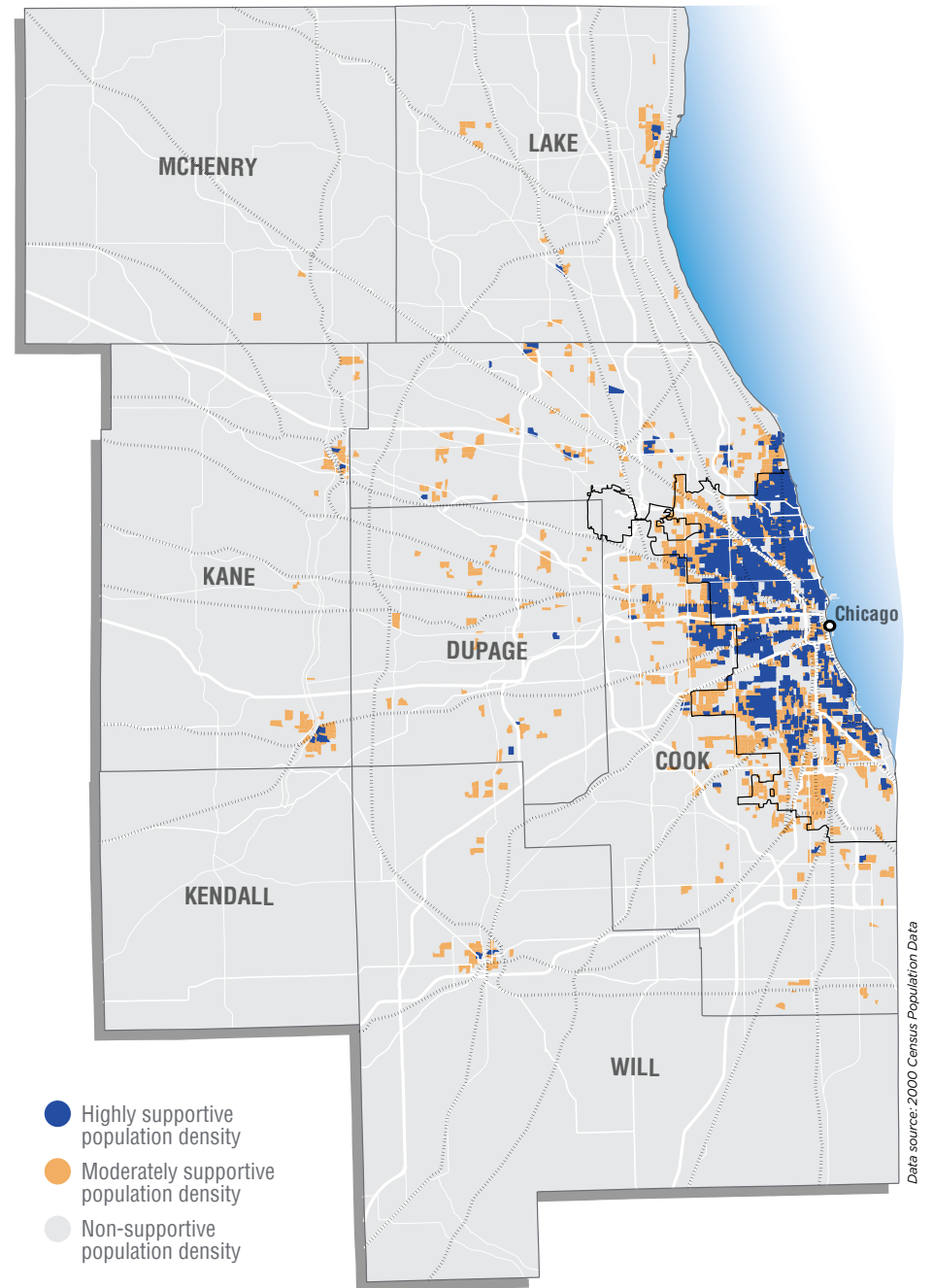



◀ **Small-Lot Single-Family Housing** of 7-10 units per acre may support basic bus service



◀ **Townhouses** of 12-15 units per acres may support higher levels of bus service and concentrated mixed-use development



◀ **Multi-Family Housing** of 15+ units per acre tends to support the highest levels of bus service and more extensive mixed-use development

TRANSIT SUPPORTIVE LAND USES IMPLEMENTATION CHECKLIST

Guideline Principles	Implementation Tools
Target office, service, or residential uses that place more people closer to transit stops	Local zoning regulations
Seek land uses that generate pedestrian foot traffic	Local zoning regulations
Pursue a mix of land uses that create activity at various times of the day	Local zoning regulations
Encourage mixed-use development near transit nodes	Local zoning regulations, local incentive programs
Seek development densities that support transit	Local zoning regulations, local incentive programs

Section 6b

Site Design

The manner in which development is designed has a profound impact on its ability to support transit use. Many times, appropriate uses and densities are close to transit, but design elements create barriers that cannot be overcome. This section identifies a series of site design principles intended to facilitate easy access to transit.

**ON-SITE PEDESTRIAN
CIRCULATION 118**

**OPEN SPACE
AND LANDSCAPING 119**

ON-SITE PEDESTRIAN CIRCULATION

Pedestrian connections between transit and private development are critical to the success of bus service. Private development should provide a direct and continuous sidewalk connection between the sidewalk in the public right-of-way and entry on the front building façade. This path should be at least 5' wide and provide as direct a route as possible from the transit service.

OPEN SPACE AND LANDSCAPING

Where appropriate, private development should incorporate open spaces that complement internal uses and create activity near transit stops. Plazas or green spaces can host secondary uses (i.e. café seating or sidewalk retail displays) and create a strong visual relationship between a transit stop and uses inside a building. Landscaping should also be used to reinforce this connection. Planters, landscaped areas and trees should be used to create attractive pedestrian paths that make access to transit comfortable and desirable.



SITE DESIGN IMPLEMENTATION CHECKLIST

Guideline Principles

Provide a direct and continuous sidewalk connection between the sidewalk in the public right-of-way and entry on the front building façade

Incorporate open spaces that complement uses and create activity near transit stops

Implementation Tools

Local zoning regulations, local subdivision regulations

Local subdivision regulations

Section 6c

Parking & Access Management

Transit-supportive design should not neglect parking. Rather, parking should be integrated as an element that can bolster the vitality of a local area and, if managed properly, not compromise the effectiveness of transit service and access.

PARKING LOCATION	122
PARKING LOT ACCESS	123
ON-SITE PARKING CAPACITY	124
PARKING DESIGN STANDARDS	125

PARKING LOCATION

Parking should be considered a secondary means of access to transit. (The exception may be at designated park-and-ride areas. However, long-term planning should consider the transition of park-and-ride areas into transit supportive development districts.) No parking lot/area, whether it is designated for a specific use or park-and-ride purposes, should be located such that a pedestrian must pass through the lot to reach adjacent uses. Parking should be located immediately adjacent to a transit stop if there is no use on the other side that relies on pedestrian access from the stop location. In areas where pedestrians are currently required to cross a parking area to access a transit stop or desired destination, the parking area should be retrofit with a designated and highly visible pedestrian path.

Parking for disabled persons should be provided throughout all developments, including on-street and on-site parking. The locations of these parking spaces should meet local municipal requirements and consider proximity to transit stops.

- vii See RTA's [Access and Parking Strategies for Transit-Oriented Developments](#) for standards regarding parking ratios, parking maximums, and other strategies for reducing the amount of parking for new transit-oriented developments.

- x see references (page iii)



Rear Parking

Locating the parking in the rear allows transit stops to be located closer to local land uses.

PARKING LOT ACCESS

Curb cuts and driveways that provide access to parking areas often disrupt pedestrian access to transit. Access to parking lots should be designed to minimize disruptions to the sidewalk network between a structure and the nearest transit stop. The following are tools that can be used by developers and local municipalities to encourage good access management.

Thoughtful site design can minimize conflicts between motorists and pedestrians. Driveways and parking aisles should be sited and designed to provide pedestrians uninterrupted paths to transit and the public sidewalk network. Where sidewalks and driveways must cross, raised crosswalks, bollards and lighting, and/or pedestrian signage can be used to give pedestrians the priority.

Secondary parking lot access should be encouraged. Rather than providing multiple curb cuts from the primary street that is most likely to accommodate pedestrian traffic, development should be encouraged to provide all parking access from a secondary street or alley. Where no secondary street or alley access is possible, curb cuts should be limited to one curb cut, across which a consistent sidewalk is maintained.

Cross-access between sites is an effective way to manage on-site traffic flow. It allows adjacent sites to reduce the number of curb cuts, thereby maintaining a constant public sidewalk environment. It also removes traffic from the roadway, enhancing transit operations and other vehicular traffic flow.



Managed Parking Access

Parking access provided from secondary streets maintains the sidewalk network along heavily used primary pedestrian corridors.

ON-SITE PARKING CAPACITY

Many places in the Chicagoland region require extensive on-site parking capacity to accommodate cars. However, transit supportive environments should minimize parking requirements to preserve land for development and foster pedestrian mobility. The following are tools local municipalities can use to help manage parking capacity in order to create transit supportive areas.

- » Local zoning ordinances can establish transit supportive districts that either waive or reduce parking requirements. Zoning can also be used to incentivize quality development and bike parking through reduced on-site parking requirements. It can also be used to encourage spaces reserved for Pace vanpool or RideShare participants.
- » Shared parking agreements can be encouraged. Such agreements permit uses that generate parking demands during different times of the day or week to share the capacity of one facility. For example, an office may use the capacity of a lot during the work week, while a church uses the lot for evening or weekend events.
- » A municipal parking program can effectively manage parking in a transit environment. Lots, structures, and signage provide the infrastructure and information necessary to enhance an area served by transit. Communities typically use fees in lieu of parking or local economic development tools to implement such programs.



PARKING DESIGN STANDARDS

Zoning ordinances establish standards for the design of parking facilities, including parking space dimensions, aisle dimensions and configurations, and landscaping. While the design of parking lots is not specifically a transit supportive issue, it can have an impact on how much land is used and the way it is used. Parking design standards should use minimum dimensions in order to maximize the use of land for development density. The following table compares typical suburban parking design standards to more transit supportive standards.

Parking Lot Element	Typical Suburban Requirement	Transit-supportive Metric
Drive Aisle (with no parking)		
One-way	12'	10'
Two-way	24'	22'
Drive Aisle - One-way		
A1 45-degree parking	13-15'	13'
A2 60-degree parking	18-20'	18'
A3 90-degree parking	24'	22'
Drive Aisle - Two-way		
B1 45-degree parking	24'	22'
B2 60-degree parking	24'	22'
B3 90-degree parking	24'	22'
B4 Parallel parking	24'	22'
Standard Parking Space		
C1 Width	10-11'	8-8.5'
C2 Depth	20'	18'
Parking Bay Depth*		
D1 45-degree parking	20'	18.5'
D2 60-degree parking	22'	19.5'
D3 90-degree parking	20'	18'

Source of dimensions from Institute of Transportation Engineers (ITE)

Parallel parking

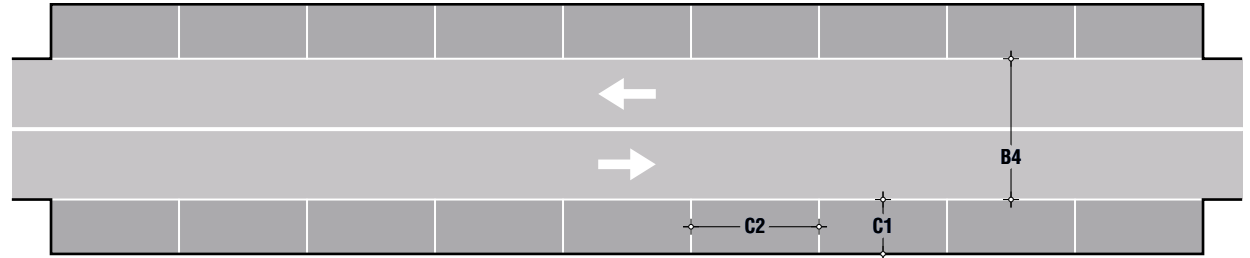

45° parking - One Way

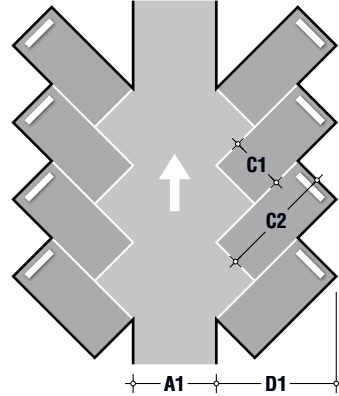

60° parking - One Way

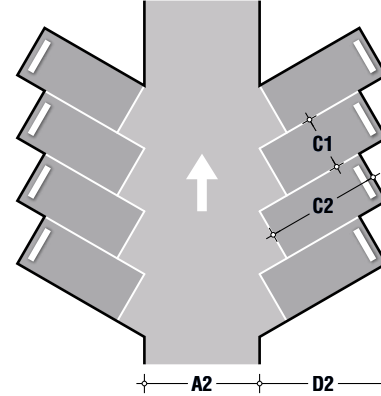

90° parking - One Way

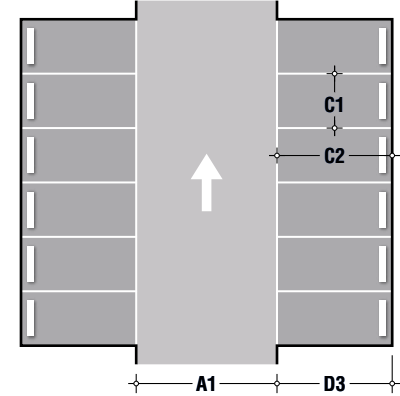

45° parking - Two Way

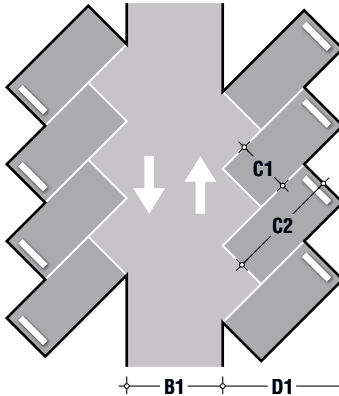

60° parking - Two Way

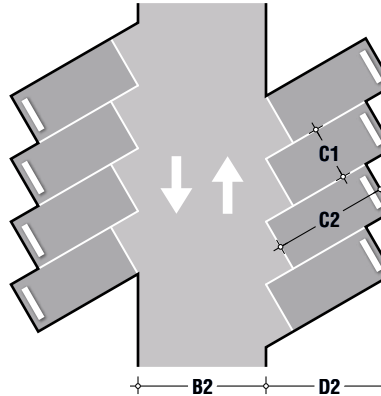

90° parking - Two Way

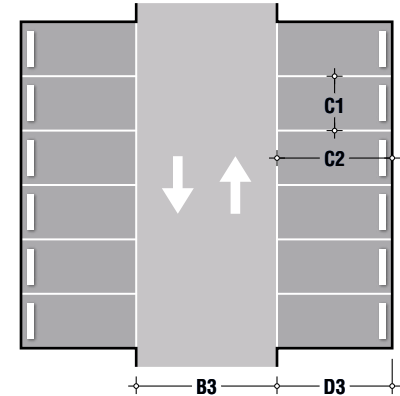

PARKING AND ACCESS MANAGEMENT IMPLEMENTATION CHECKLIST

Guideline Principles	Implementation Tools
Locate off-street parking areas so that they do not interfere with pedestrian circulation routes	Local zoning regulations
Minimize disruptions to the sidewalk when designing a parking lot	Local zoning regulations
Maximize multi-modal infrastructure within existing right-of-way	Local subdivision regulations, local public works/engineering standards, D.O.T standards
Reduce the amount of required off-street parking through lower ratios, parking maximums, incentives, etc.	Local zoning regulations
Use minimum dimensions for parking lot design	Local zoning regulations, local subdivision regulations

Section 6d

Building Design

There are functional aspects of building design that impact how effective transit supportive local development may be. However, there are also qualitative aspects that impact the character and desirability of an area. Communities throughout Chicagoland vary greatly in terms of local character based on their local histories and development influences. These guidelines are not intended to create a consistent character throughout the region. Rather, they are intended to illustrate some of the fundamental principles that exist in most successful transit supportive places.

BUILDING DESIGN

The following elements of building design impact the local character of a place. The general elements provide the flexibility for communities to integrate more specific character-defining elements such as architectural style, lighting and signage, details, etc.

BUILDING ACCESS

Development should strive to provide direct access from local transit service to the uses it hosts. Buildings should be designed to include a prominent and attractive building entrance that is as close to transit service as possible. Pedestrian access from the public street should not be considered secondary to access from a parking area. Architectural massing, design details, signage, lighting and landscaping should all be used to articulate the primary pedestrian entrance.

MASSING AND SCALE

Buildings should use massing and scale to create comfortable, pedestrian-scale places. Interesting corner elements, set-back upper facades, variations in rooflines, and other design techniques make the street environment more attractive for pedestrians.

FAÇADE DESIGN

Pedestrians experience buildings more intimately and at slower speeds than motorists. Their experience is most closely influenced by the façade of the building along which they are walking. Facades can create a comfortable pedestrian environment by incorporating design elements (such as columns, awnings, cornices, etc.) that break up blank walls and reflect traditional design characteristics. While the level of transparency may vary based on the specific use and architectural style, ground-floor facades should include between 40% and 60% of window area.

DESIGN DETAILS AND MATERIALS

Design details and materials should reinforce local community character. They should be used to create an interesting and attractive environment that makes transit and pedestrian mobility a desirable alternative.

LIGHTING AND SIGNAGE

Buildings should include lighting and signage that reflect the scale and travel speeds of pedestrians. With buildings placed closer to the public sidewalk, development should rely primarily on wall signage to identify businesses. Any detached signage (i.e. pole or monument signs) should be small-scale and maintain safe visibility lines between the public sidewalk and driveway entrances. Lighting should be integrated into the building facades in order to provide adequate illumination for a safe sidewalk environment.



BUILDING DESIGN IMPLEMENTATION CHECKLIST

Guideline Principles	Implementation Tools
Design prominent and easily-identifiable front entrances to buildings that are as close to transportation as possible	Local zoning regulations, design standards, architectural guidelines
Create an attractive street environment through architectural design elements that enhance the pedestrian experience	Local zoning regulations, local subdivision regulations, design standards, architectural guidelines
Design facades that have transparency and articulation through the use of both horizontal and vertical elements	Local zoning regulations, design standards, architectural guidelines
Utilize wall-mounted signage and integrated lighting features to enhance the pedestrian experience	Local zoning regulations, design standards, architectural guidelines
Reinforce local community character through the use of design motifs and materials	Local zoning regulations, design standards, architectural guidelines

Section 6e

On-site Transit Facilities

In some instances, such as major bus transfer facilities at regional shopping centers or local shuttle routes that serve an office campus, transit services and facilities may be integrated into private development. When this occurs transit should be considered in terms of building location, site access and circulation, pedestrian access to transit and surrounding uses, local facilities and amenities, and signage and information. Transit access should not be thought of as secondary to vehicular access, but rather as a key component to the success of local development.

**SITE ACCESS AND
CIRCULATION 132**

**TRANSIT
FACILITY DESIGN 133**

SITE ACCESS AND CIRCULATION

Leaving the primary service corridor to serve private development is a potential barrier to providing efficient bus service. To minimize delays and traffic conflicts while servicing private development, the following principles should be followed.

- » The on-site transit center should be located so that it is as close as possible to the streets on which the transit service operates. Property owners and designers should work with Pace to determine the best location.
- » Access from the public street should be provided at logical entry points. These should provide a direct route for transit vehicles to the on-site transit center.
- » To the extent possible, dedicated transit circulator lanes should be provided to enhance efficiency and minimize low-speed collisions with other vehicles.
- » On-site pedestrian networks should connect the transit center to the public sidewalk and any surrounding uses. Raised crosswalks, unique pavers, bollards, lighting and/or signage should be used to delineate pedestrian paths where they cross parking aisles or internal streets.
- » Roadway or parking lot segments used for on-site circulation should be designed to accommodate transit vehicles. Designers should work closely with Pace to determine the vehicles that could serve a given facility.



- 1** Bus vehicle access and circulation
- 2** Passenger Boarding Area
- 3** In-door Waiting Area

TRANSIT FACILITY DESIGN

In order to provide the best possible transit service to local development, property owners should work closely with Pace to identify elements of the transit center design program. At a minimum, the design program must consider vehicle access between the private road network and transit center, vehicle stacking and storage areas, passenger loading

and waiting areas, and basic amenities for rider comfort. Depending on the type of transit facility and intensity of service, additional amenities may be warranted, including an operator break area and restroom, enclosed bicycle lockers, fare card and information kiosks, etc. Since each location may vary based on local development issues, Pace should be consulted as to the extent of the design program and its specific application for a given site.

ON-SITE TRANSIT FACILITIES IMPLEMENTATION CHECKLIST

Guideline Principles	Implementation Tools
Locate transit center on a street nearest to the transit route	Local zoning regulations, local subdivision regulations
Provide direct connection between transit center and street	Local zoning regulations, local subdivision regulations
Provide pedestrian connection between transit center and sidewalk along street	Local zoning regulations, local subdivision regulations
Work with Pace to identify elements of the transit center design program that best suite the particular site	Local zoning regulations

Chapter 7

Appendix

Pulse Addendum Added February 2024

COMPREHENSIVE TRANSIT
CHECKLIST

TECHNICAL
REFERENCES & DRAWINGS

COMPREHENSIVE TRANSIT CHECKLIST

The following is a compilation of all the implementation checklists included in this document. The checklist is organized by major technical topics that correspond with chapters and subsections of this document.

VEHICLE, SERVICE & ROADWAY

Guideline Principles	Implementation Tools
Design standards are used that reflect specific transit vehicles to be used in the development area in terms of lane width, curb radius, pavement construction, etc.	Local subdivision regulations, local public works/engineering standards, D.O.T standards
Design for appropriate outside turning clearance at all locations where Pace vehicles operate.	Local public works/engineering standards, D.O.T standards
For all roadways that accommodate transit operations, appropriate lane widths are used to ensure proper maneuverability of transit vehicles.	Local zoning and subdivision regulations, local public works/engineering standards, D.O.T standards
Design minimal grades to the extent possible for roadways serviced by Pace vehicles and comply with ADA standards at stops and throughout the pedestrian network.	Local public works/engineering standards, D.O.T standards
Pavement should be designed to handle anticipated vehicle loads.	Local public works/engineering standards, D.O.T standards
Consider the long-term implementation of level boarding and precision docking when engineering bus stop areas.	Local public works/engineering standards, D.O.T standards
Bicycle lanes are appropriately integrated into the design of roadway and transit infrastructure.	Local public works/engineering standards, D.O.T standards
Use appropriate lane markers to differentiate between transit areas, bicycle lanes, on-street parking, etc.	Local public works/engineering standards, D.O.T standards

BUS STOP LOCATION AND ROADWAY DESIGN

Guideline Principles	Implementation Tools
Working closely with Pace, determine the appropriate location for transit stops and facilities based on local conditions.	Local public works/engineering standards, D.O.T standards
Design appropriate clearances from on-street parking, intersections, etc. based on the location of the bus stop.	Local public works/engineering standards, D.O.T standards
To the extent possible, use rigid roadway surfaces at bus stops, bus turnouts, and transit terminals.	Local public works/engineering standards, D.O.T standards
Coordinate with Pace in selecting appropriate bus bay configurations to ensure efficient bus service on busy streets.	Local public works/engineering standards, D.O.T standards
Coordinate with Pace to implement suitable transit technologies (such as queue jumps and transit signal priority) when roadway geometry and traffic conditions permit	Local public works/engineering standards, D.O.T standards

OFF-STREET FACILITIES

Guideline Principles	Implementation Tools
Coordinate with Pace to appropriately integrate off-street bus facilities into development.	Local zoning and subdivision regulations, Local public works/engineering standards, D.O.T standards
Coordinate with Pace to accommodate appropriate bus turnarounds as needed.	Local public works/engineering standards, D.O.T standards
Design bus circulation routes, berths, and turnarounds to accommodate anticipated transit vehicles.	Local zoning and subdivision regulations, Local public works/engineering standards, D.O.T standards
Design park-n-ride facilities that consider parking facility size, waiting areas, and pedestrian access, and incorporate bus berths and turnarounds into design.	Local zoning and subdivision regulations, Local public works/engineering standards, D.O.T standards
Provide a fully accessible pedestrian path between bus boarding/alighting areas, nearby uses and structures, and other modes of transportation.	Local zoning and subdivision regulations, Local public works/engineering standards, D.O.T standards

PASSENGER WAITING AREAS

Guideline Principles	Implementation Tools
Address bus stop accessibility for all users early in the decision making process for all bus stop plans	Local zoning and subdivision regulations, Local public works/engineering standards, D.O.T standards
Coordinate with Pace to design bus stop locations with amenities to provide a comfortable, safe, and convenient waiting area for transit users	Local public works/engineering standards
Coordinate with Pace to provide passenger shelters for bus stop areas that are high volume boarding sites	Local public works/engineering standards
Coordinate with Pace to integrate transit route information, local wayfinding, and/or Intelligent Transportation Systems (ITS) to provide accurate route and schedule information to the public.	Local public works/engineering standards, D.O.T standards

STREET NETWORK DESIGN

Guideline Principles	Implementation Tools
Design a well-connected grid pattern of streets that maximizes network connections.	Local zoning regulations, local subdivision regulations
Plan small block sizes that foster high levels of local walkability.	Local subdivision regulations
Maximize multi-modal infrastructure within existing right-of-way.	Local subdivision regulations, local public works/engineering standards
Limit traffic lanes widths to the minimum allowable standard in order to accommodate bike lanes, adequate sidewalk width, etc.	Local subdivision regulations, local public works/engineering standards, D.O.T standards
Keep curb radii to the minimum allowable standard in order to minimize pedestrian crossing distances.	Local public works/engineering standards, D.O.T standards
Coordinate the design and installation of infrastructure and pedestrian amenities.	Local subdivision regulations, local public works/engineering standards, D.O.T standards

CREATING SAFE AND COMFORTABLE SIDEWALKS

Guideline Principles	Implementation Tools
Provide adequate width on public sidewalks and landscape areas in order to accommodate curbside amenities that enhance the pedestrian environment.	Local subdivision regulations, local public works/engineering standards, D.O.T standards
Provide on-street parking, and coordinate its design with transit operations and stop locations.	Local public works/engineering standards, D.O.T standards
Connect transit stops to the sidewalk network	Local subdivision regulations, local public works/engineering standards, D.O.T standards

MANAGING SHARED PEDESTRIAN/ VEHICULAR SPACES

Guideline Principles	Implementation Tools
Traffic Calming	
Use lane widths and geometries to reduce traffic speeds and enhance pedestrian safety where it can be done without compromising transit operations or on-time performance.	Local public works/engineering standards, D.O.T standards
Use textured roadway materials or visible striping to call motorist's attention to unique areas.	Local public works/engineering standards, D.O.T standards
Install speed tables in at-grade pedestrian crossings that require slow vehicle speeds and increase pedestrian visibility.	Local public works/engineering standards, D.O.T standards
Plan on-street parking, which slows traffic through the inherent actions of parking vehicles and opening car doors.	Local public works/engineering standards, D.O.T standards
Signage and Information	
Install pedestrian crossing signals at every signalized intersection, especially those with high levels of pedestrian activity.	Local public works/engineering standards, D.O.T standards
Install pedestrian crossing warning systems where appropriate.	Local public works/engineering standards, D.O.T standards
Use highly visible pedestrian crosswalk painting design.	Local public works/engineering standards, D.O.T standards
Pedestrian Comfort	
Utilize curb bump-outs, pedestrian refuge islands, and clearly delineated crosswalks.	Local public works/engineering standards, D.O.T standards

TRANSIT SUPPORTIVE LAND USES

Guideline Principles	Implementation Tools
Target office, service, or residential uses that place more people closer to transit stops	Local zoning regulations
Seek land uses that generate pedestrian foot traffic	Local zoning regulations
Pursue a mix of land uses that create activity at various times of the day	Local zoning regulations
Encourage mixed-use development near transit nodes	Local zoning regulations, local incentive programs
Seek development densities that support transit	Local zoning regulations, local incentive programs

SITE DESIGN

Guideline Principles	Implementation Tools
Provide a direct and continuous sidewalk connection between the sidewalk in the public right-of-way and entry on the front building façade	Local zoning regulations, local subdivision regulations
Incorporate open spaces that complement uses and create activity near transit stops	Local subdivision regulations

PARKING AND ACCESS MANAGEMENT

Guideline Principles	Implementation Tools
Locate off-street parking areas so that they do not interfere with pedestrian circulation routes	Local zoning regulations
Minimize disruptions to the sidewalk when designing a parking lot	Local zoning regulations
Maximize multi-modal infrastructure within existing right-of-way	Local subdivision regulations, local public works/engineering standards, D.O.T standards
Reduce the amount of required off-street parking through lower ratios, parking maximums, incentives, etc.	Local zoning regulations
Use minimum dimensions for parking lot design	Local zoning regulations, local subdivision regulations

BUILDING DESIGN

Guideline Principles	Implementation Tools
Design prominent and easily-identifiable front entrances to buildings that are as close to transportation as possible	Local zoning regulations, design standards, architectural guidelines
Create an attractive street environment through architectural design elements that enhance the pedestrian experience	Local zoning regulations, local subdivision regulations, design standards, architectural guidelines
Design facades that have transparency and articulation through the use of both horizontal and vertical elements	Local zoning regulations, design standards, architectural guidelines
Utilize wall-mounted signage and integrated lighting features to enhance the pedestrian experience	Local zoning regulations, design standards, architectural guidelines
Reinforce local community character through the use of design motifs and materials	Local zoning regulations, design standards, architectural guidelines

ON-SITE TRANSIT FACILITIES

Guideline Principles	Implementation Tools
Locate transit center on a street nearest to the transit route	Local zoning regulations, local subdivision regulations
Provide direct connection between transit center and street	Local zoning regulations, local subdivision regulations
Provide pedestrian connection between transit center and sidewalk along street	Local zoning regulations, local subdivision regulations
Work with Pace to identify elements of the transit center design program that best suite the particular site	Local zoning regulations

TECHNICAL DRAWINGS AND REFERENCES

The following drawings provide additional technical information pertaining to many of the design concepts presented in this document. The drawings are taken from external industry standards and sources referenced throughout this document.

These drawings are intended to provide guidance for concept design. However, for more detailed design and specifications, official sources should be referenced to ensure that up-to-date standards are being implemented.

TYPICAL STREET CROSS-SECTIONS AND BIKE LANES

a

42-3(12) **BUREAU OF LOCAL ROADS & STREETS** **BICYCLE FACILITIES** Jan 2006

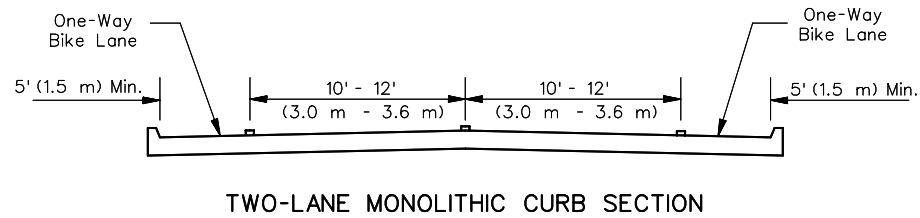
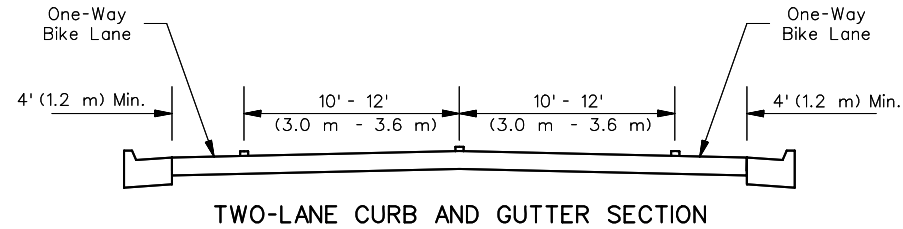

b

Jan 2006 **BUREAU OF LOCAL ROADS & STREETS** **BICYCLE FACILITIES** 42-3(13)

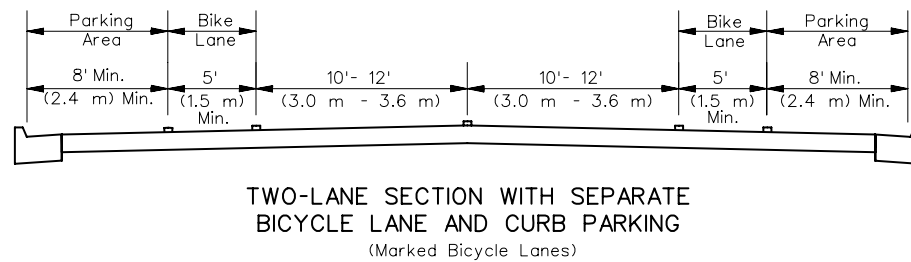
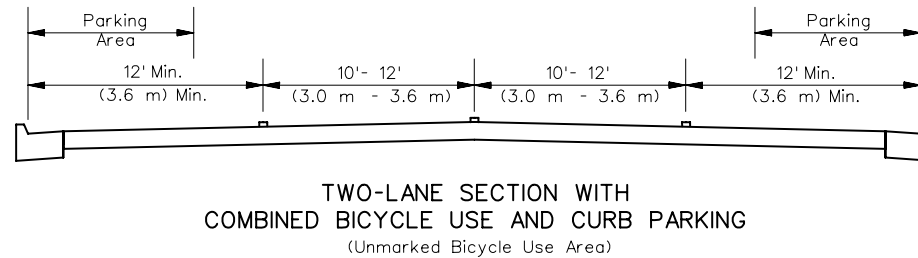

ON-STREET BUS STOP DIMENSIONS AND CLEARANCES

c

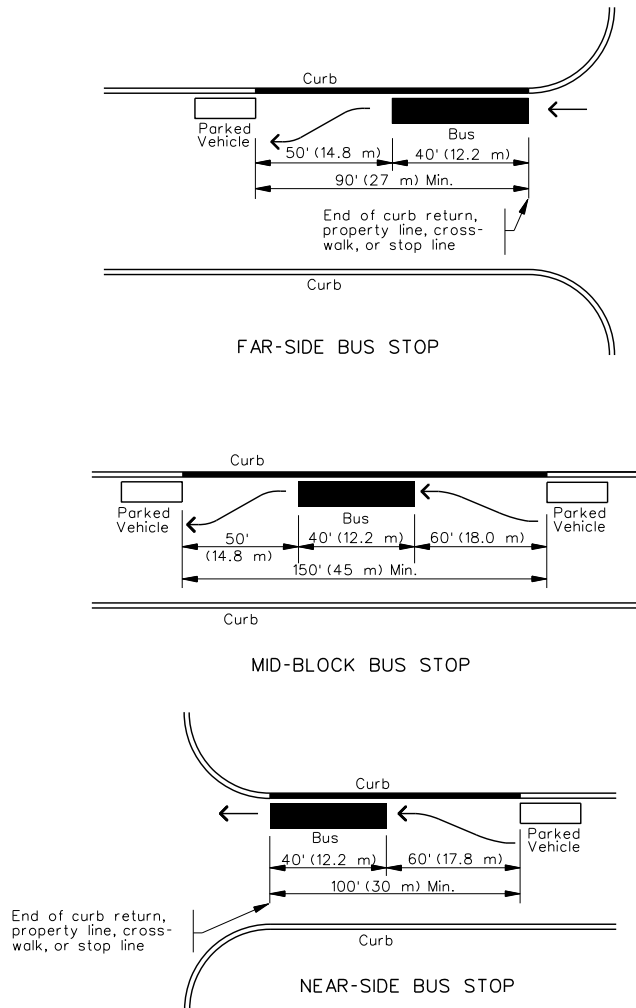

Notes:

1. Where articulated buses are expected to use these stops, add an additional 20 ft (6 m) to the bus distances.
2. Provide an additional 50 ft (15 m) of length for each additional bus expected to stop simultaneously at any given bus stop area. This allows for the length of the extra bus (40 ft (12.2 m)) plus 10 ft (2.8 m) between buses.

ON-STREET BUS STOPS

Figure 58-3.B

ACCESSIBLE BUS SHELTER BOARDING/ALIGHTING AREA AND PATH

d

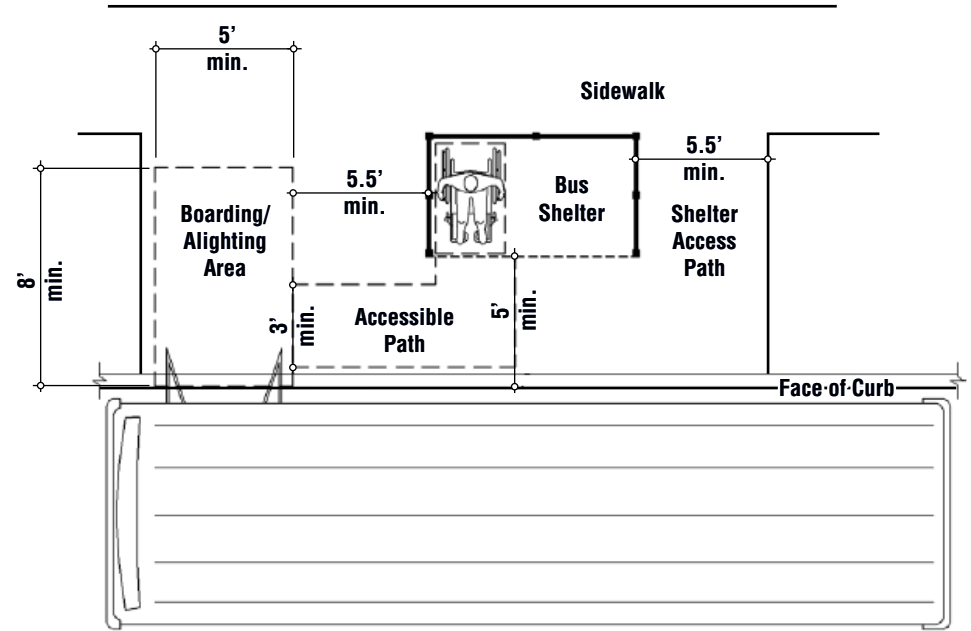

BUS TURNOUT DIMENSIONS, CLEARANCES AND STANDARDS

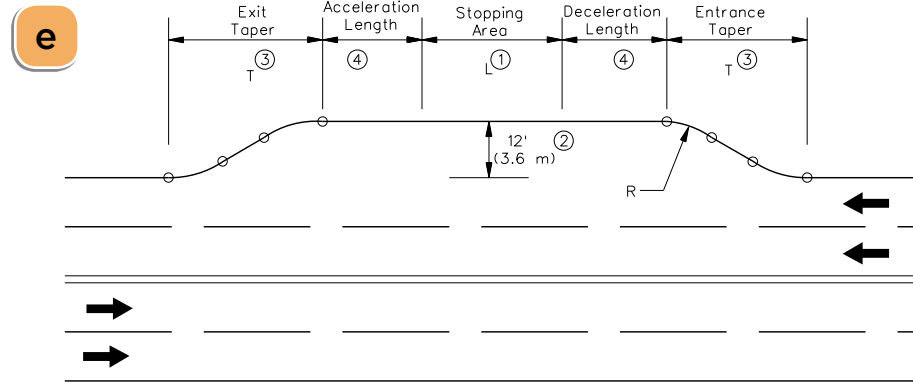

Notes:

- ① Stopping area length consists of 50 ft (15 m) for each standard 40 ft (12.2 m) bus and 70 ft (21 m) for each 60 ft (18.3 m) articulated bus expected to be at the stop simultaneously.
- ② Bus turnout width is desirably 12 ft (3.6 m). For posted speeds under 30 mph, a 10 ft (3.0 m) minimum bay width is acceptable. These dimensions do not include gutter width.
- ③ Suggested taper lengths are listed below. A minimum taper of 5:1 may be used for an entrance taper from an arterial street for a bus turnout while the merging or re-entry taper should not be sharper than 3:1.
- ④ The minimum design for a bus turnout does not include acceleration or deceleration lengths. Recommended acceleration and deceleration lengths are listed below.

Design Speed	Entering Speed*	Acceleration Lengths	Deceleration Lengths**	Suggested Taper Lengths
US CUSTOMARY				
35 mph	25 mph	250 ft	185 ft	170 ft
40 mph	30 mph	400 ft	265 ft	190 ft
45 mph	35 mph	700 ft	360 ft	210 ft
50 mph	40 mph	975 ft	470 ft	230 ft
METRIC				
50 km/h	35 km/h	60 m	45 m	45 m
60 km/h	45 km/h	105 m	70 m	50 m
70 km/h	55 km/h	200 m	105 m	60 m
80 km/h	65 km/h	310 m	145 m	70 m

* Desirably, the bus speed at the end of taper should be within 10 mph (15 km/h) of the design speed of the traveled way.

** Based on a 2.5 mph/sec (4.0 km/h/s) deceleration rate.

TYPICAL BUS TURNOUT DIMENSIONS

Figure 58-3.C

POTENTIAL BUS STOP CONFIGURATIONS AND DIMENSIONS

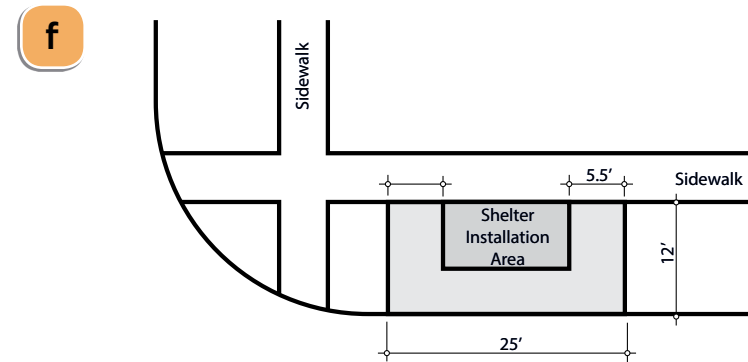

Preferred Shelter Placement and Dimensions
(Sidewalk Greater Than 12' From Curb)

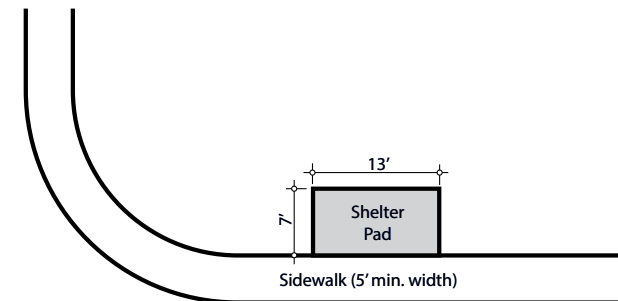

Alternative Placement
(Sidewalk Adjacent to Curb)

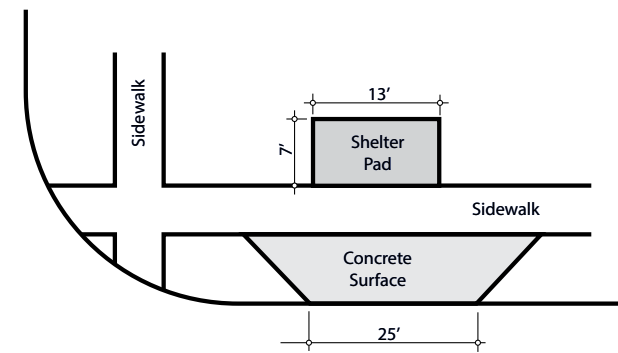

Alternative Placement
(Sidewalk Less Than 12' From Curb)

PARALLEL AND SAWTOOTH BUS BAY DIMENSIONS

g

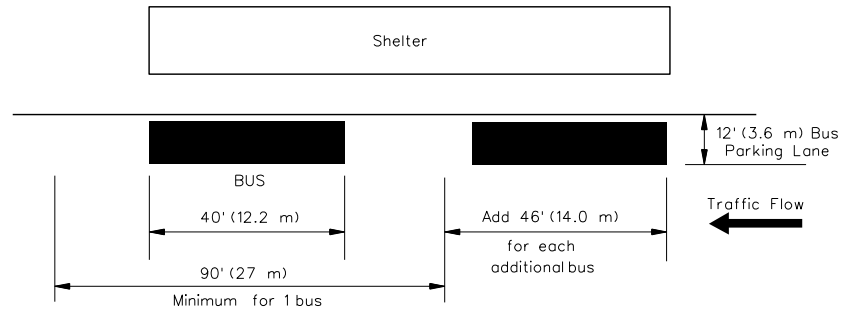

PARALLEL PARKING

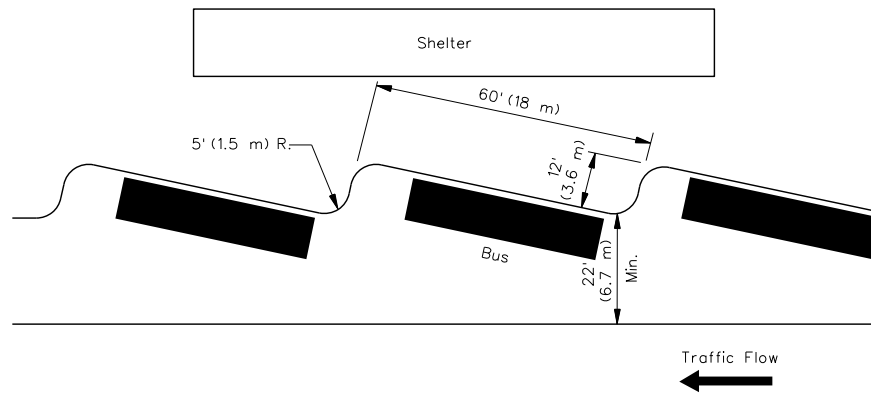

SHALLOW SAWTOOTH PARKING

RECOMMENDED LENGTHS FOR BUS-LOADING AREAS (Park-and-Ride Lots)

Figure 58-2.B

BUS TURNAROUND DIMENSIONS

h

BUREAU OF LOCAL ROADS & STREETS

SPECIAL DESIGN ELEMENTS

Jan 2006

41-1(2)

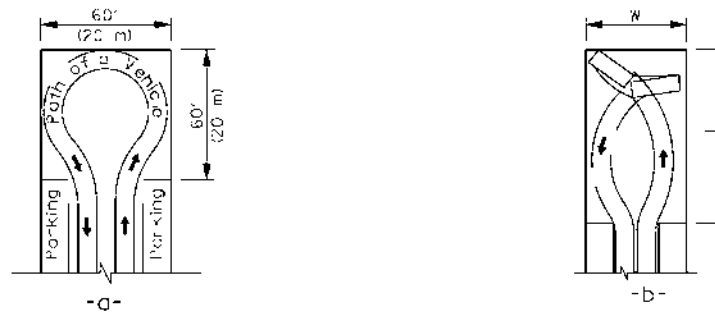

Design Vehicle	W	L
P	30 ft (10 m)	60 ft (20 m)
SU	50 ft (15 m)	100 ft (30 m)

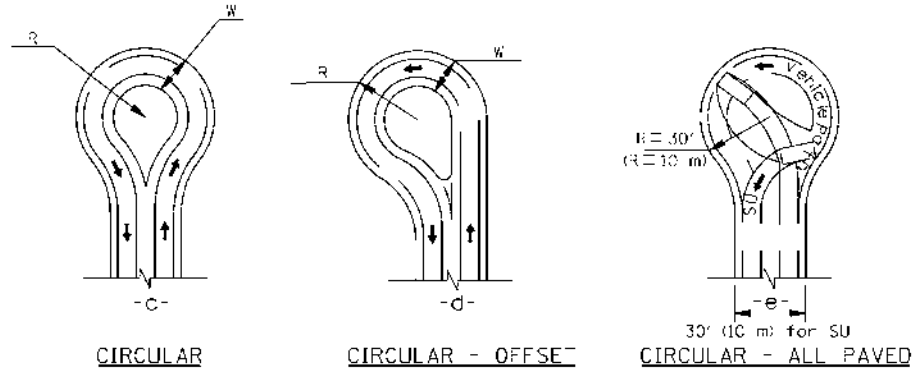

Design Vehicle	R	W
P	30 ft (10 m)	18 ft (6 m)
WB-40 (WB-12)	42 ft (13 m)	25 ft (8 m)
SU & WB-50 (WB-15)	47 ft (15 m)	30 ft (10 m)

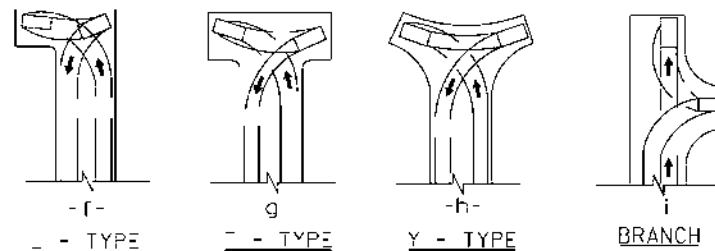

CUL-DE-SACS

Figure 41-1A

CURB CUT AND RAMP DESIGN DETAILS FOR VARIOUS LOCATIONS AND CONDITIONS

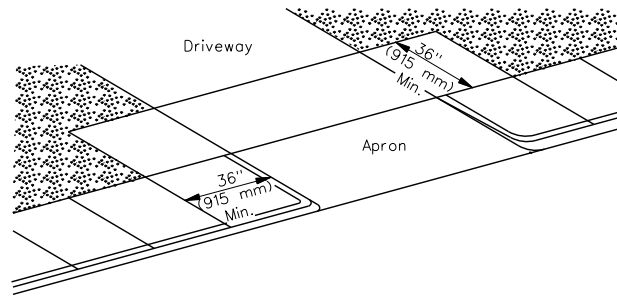

SIDEWALKS AT DRIVEWAY APRONS

Figure 58-1.D

58-1.08 Ramps

Portions of sidewalks whose running slope exceed 5% and are not following the general grade of an adjacent street or highway are considered ramps (Note: These ramps are different from curb ramps. See Section 58-1.09 for curb ramps.). The following represents the accessible criteria for ramps:

1. **Running Slope and Rise.** Ramps shall have a running slope greater than 5% up to an 8.3% maximum. The maximum rise for any single ramp run shall be 30 in (760 mm). For ramp heights greater than 30 in (760 mm), a series of ramps and landings must be used. Ramps to be constructed on existing building/facility sites or inside existing buildings/facilities may have a running slope which exceeds 8.3% within the rise limitations shown in Figure 58-1.E, if space limitations dictate.
2. **Width.** The minimum clear width of a ramp shall be 36 in (915 mm). Where handrails are provided, the clear width is measured between inside edge of the rails.
3. **Landings.** Ramps shall have level landings (preferably be 1.5% and no greater than 2% in all directions) at the bottom and top of each run and shall have the following features:
 - The landing shall be at least as wide as the widest ramp run leading to the landing.
 - The landing length shall be a minimum of 60 in (1.5 m).

58-1.10

CURB CUT AND RAMP DESIGN DETAILS FOR VARIOUS LOCATIONS AND CONDITIONS (CONT'D.)

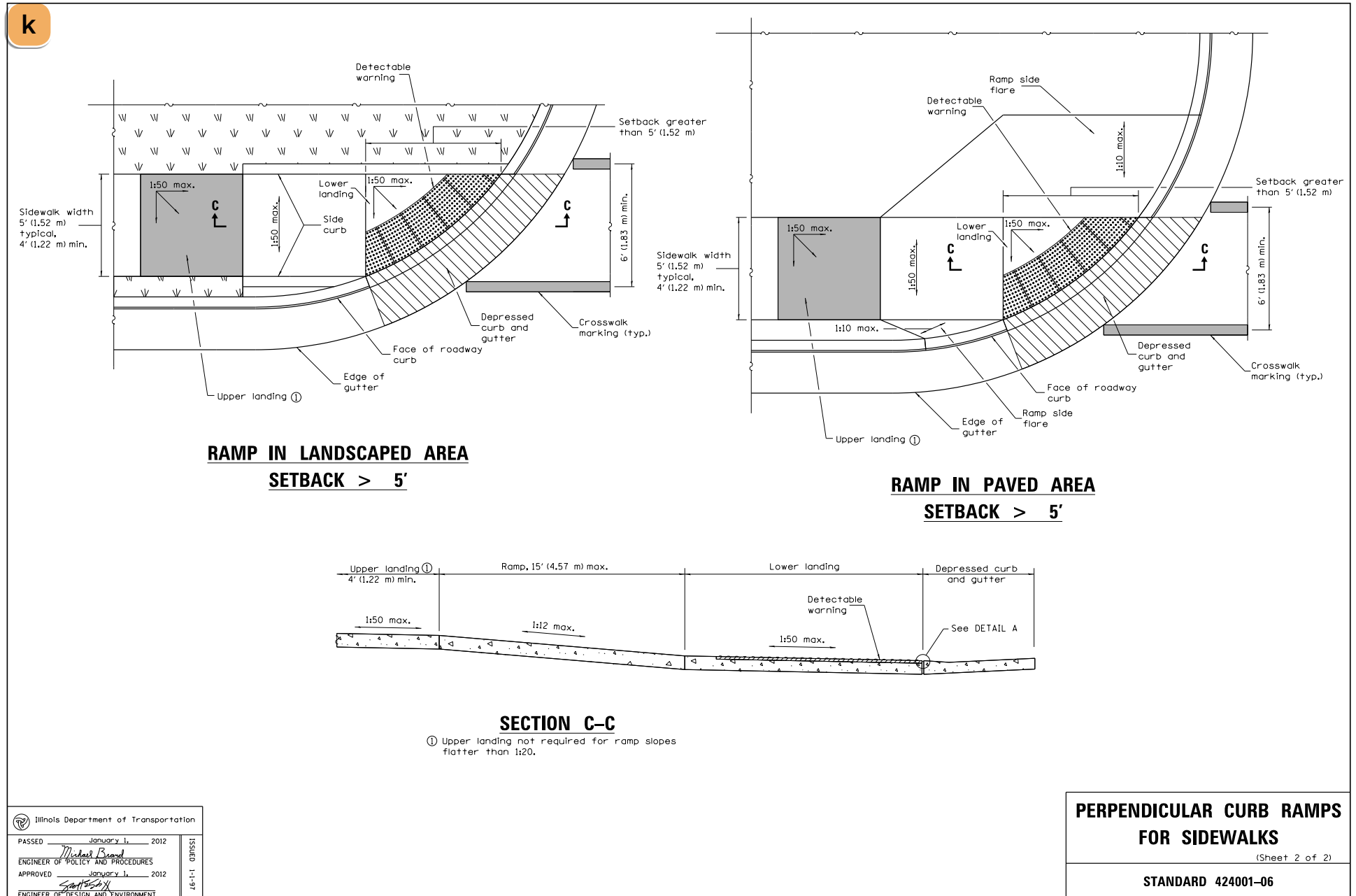

CURB CUT AND RAMP DESIGN DETAILS FOR VARIOUS LOCATIONS AND CONDITIONS (CONT'D.)

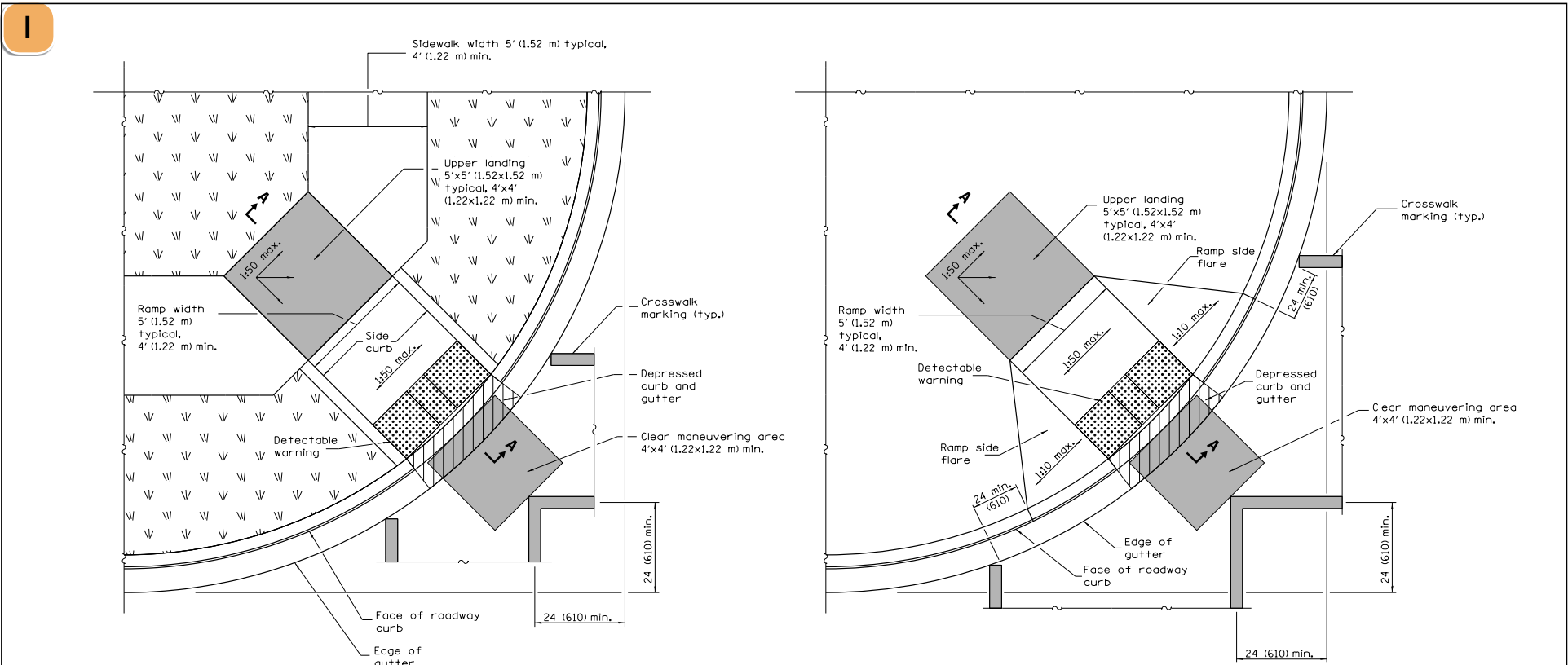

RAMP IN LANDSCAPED AREA

RAMP IN PAVED AREA

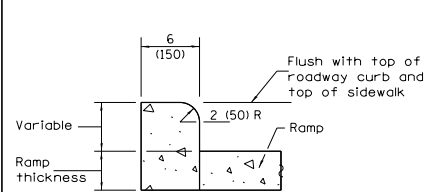

SIDE CURB DETAIL

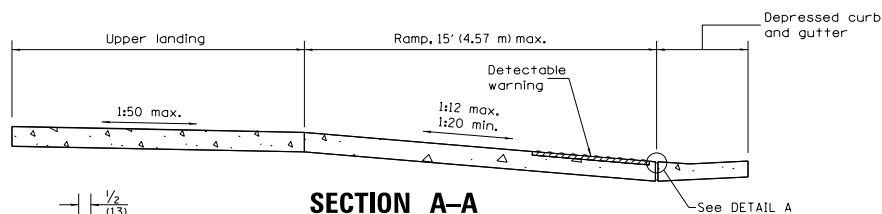

SECTION A-A

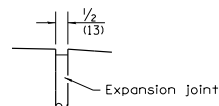

DETAIL A

GENERAL NOTES

This Standard shall only be used for curb radii of 20 ft. (6.1 m) or greater.

All slope ratios are expressed as units of vertical displacement to units of horizontal displacement (V:H).

See Standard 606001 for details of depressed curb adjacent to curb ramp.

All dimensions are in inches (millimeters) unless otherwise shown.

DATE	REVISIONS
1-1-12	New standard.

DIAGONAL CURB RAMPS FOR SIDEWALKS

STANDARD 424006

Illinois Department of Transportation

PASSED January 1, 2012

Michael Bussell
ENGINEER OF POLICY AND PROCEDURES

APPROVED January 1, 2012

Scott Smith
ENGINEER OF DESIGN AND ENVIRONMENT

ISSUED 1-1-12

CURB CUT AND RAMP DESIGN DETAILS FOR VARIOUS LOCATIONS AND CONDITIONS (CONT'D.)

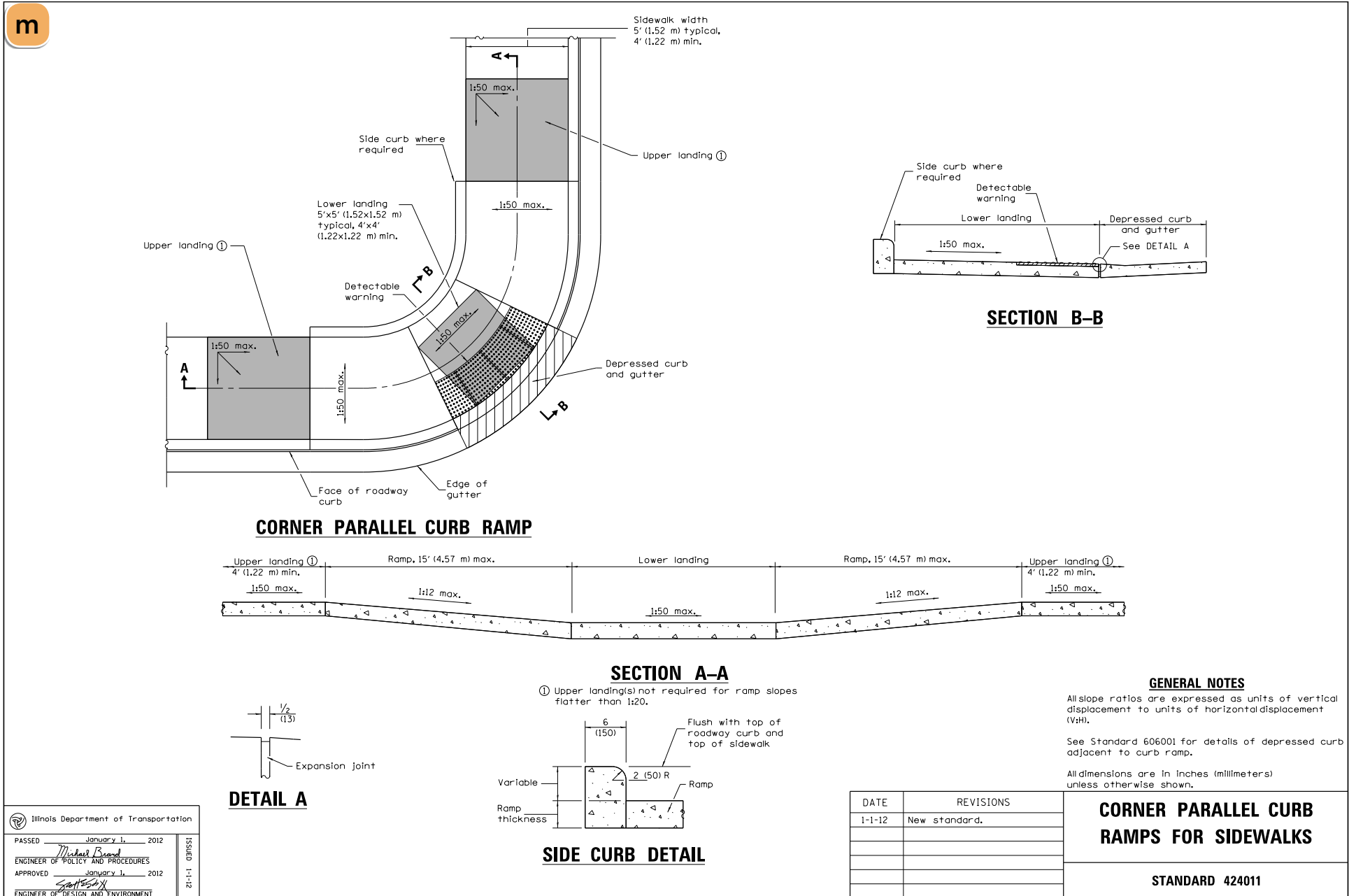

Illinois Department of Transportation

PASSED January 1, 2012
Michael Brand
 ENGINEER OF POLICY AND PROCEDURES

APPROVED January 1, 2012
Sattler
 ENGINEER OF DESIGN AND ENVIRONMENT

ISSUED 1-1-12

CURB CUT AND RAMP DESIGN DETAILS FOR VARIOUS LOCATIONS AND CONDITIONS (CONT'D.)

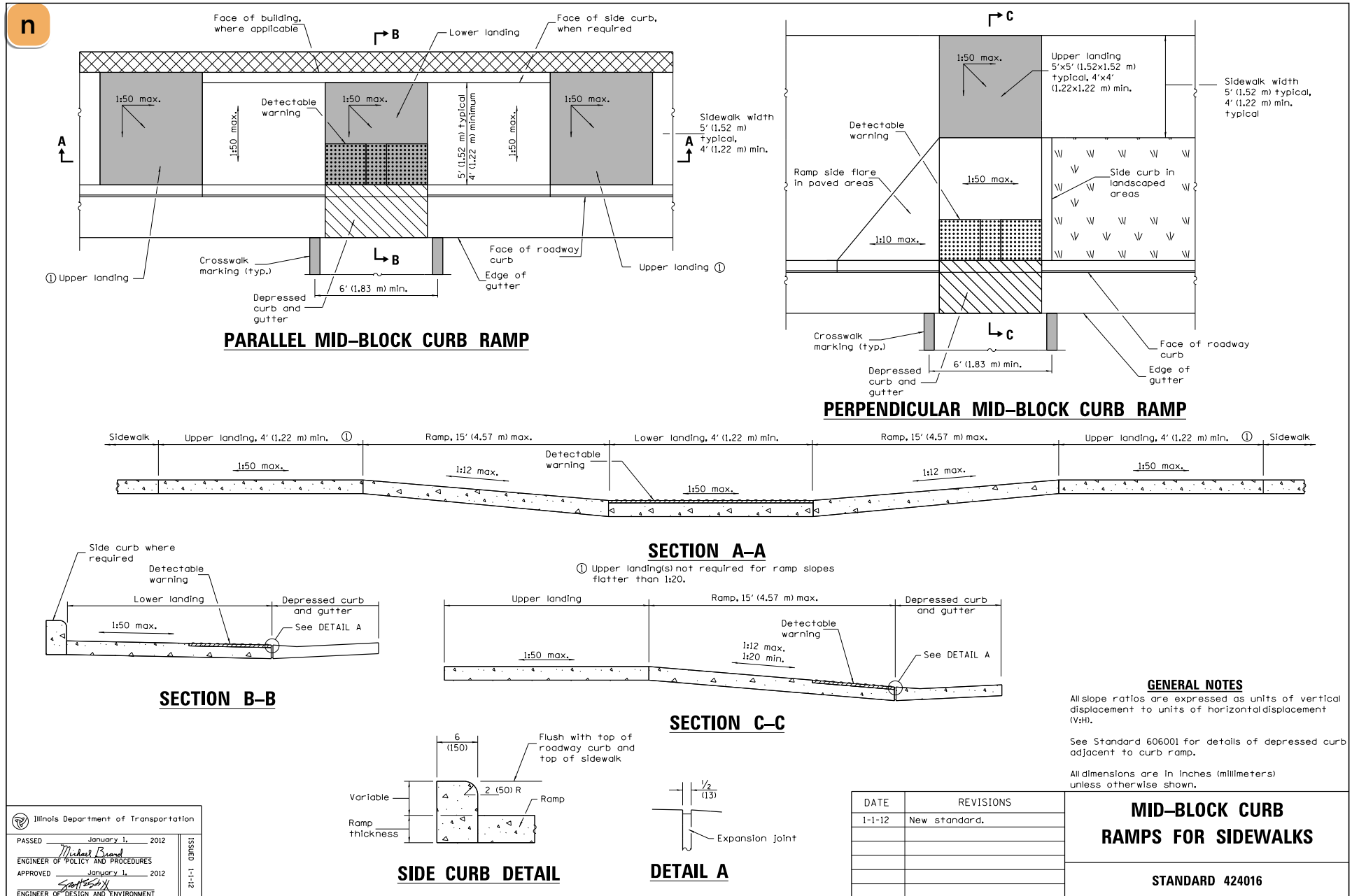

Illinois Department of Transportation
 PASSED January 1, 2012
 ENGINEER OF POLICY AND PROCEDURES
 APPROVED January 1, 2012
 ENGINEER OF DESIGN AND ENVIRONMENT

DATE	REVISIONS
1-1-12	New standard.

MID-BLOCK CURB RAMPS FOR SIDEWALKS

STANDARD 424016

Addendum

Guidelines for Pace Pulse Infrastructure & Facilities

This 2024 addendum to Pace's Transit Supportive Guidelines focuses on tailored development standards for Pulse arterial bus rapid transit service. Through collaboration with units of government, developers, and private property owners, Pulse drives economic development, improves accessibility, and enhances the overall quality of life in our region.

OVERVIEW OF THE PULSE PROGRAM

The Pulse program mission is to provide fast, frequent, and reliable bus service on heavily traveled corridors in Chicagoland. The Pulse program enhances the transit experience by offering high quality service and amenities to passengers.

Pulse service includes the following features:

- » Faster service with limited stops and priority movements at signalized intersections.
- » Pulse-branded buses with free Wi-Fi and next-station digital signage.
- » Modern, Pulse-branded stations with heated shelters, benches, bike racks, and trash receptacles.
- » Real-time bus tracker information.
- » Near-level boarding platforms for an easier boarding experience.



Southbound Touhy Station on the Pulse Milwaukee Line | Photo by Andy Ryan

As part of Pace's strategic vision plan, *Driving Innovation*, Pace is committed to expanding its network of Pulse service. To see the latest Pulse developments, visit pacebus.com/pulse.

These guidelines are intended to help local, county, and state agency partners prepare for Pulse implementation and maximize the value of the Pulse investment for local communities. Guidelines cover the topics of station placement, right-of-way requirements, queue jumps and bus lanes, bus-bike interfacing, utility work and streetscaping

improvements, local permitting and advertising revenue, local signage, security, and community expression.

STATION AMENITIES

Pulse stations have several amenities to increase the comfort of Pace passengers including heated shelters with interior lighting, panel walls to protect passengers from inclement weather, and benches. Stations contain elements such as an audio enunciator and tactile warning strips to ensure accessibility for all passengers. The 12-inch raised platform height makes it easier to step onto buses for a near-level boarding experience. Additional amenities include real-time bus tracker information, a local area map, a trash receptacle, and a bike rack. Stations also have heated pavement to melt away snow. Customized art on the panels of each individual shelter also offer a greater sense of place and personalized experience to Pulse travel. Railings behind the platform protect passengers on the raised platform and further enhance the sense of place within the station.

Some station amenities are modified or reduced for the length-constrained and depth-constrained Pulse station designs described in the Station Sizes section.

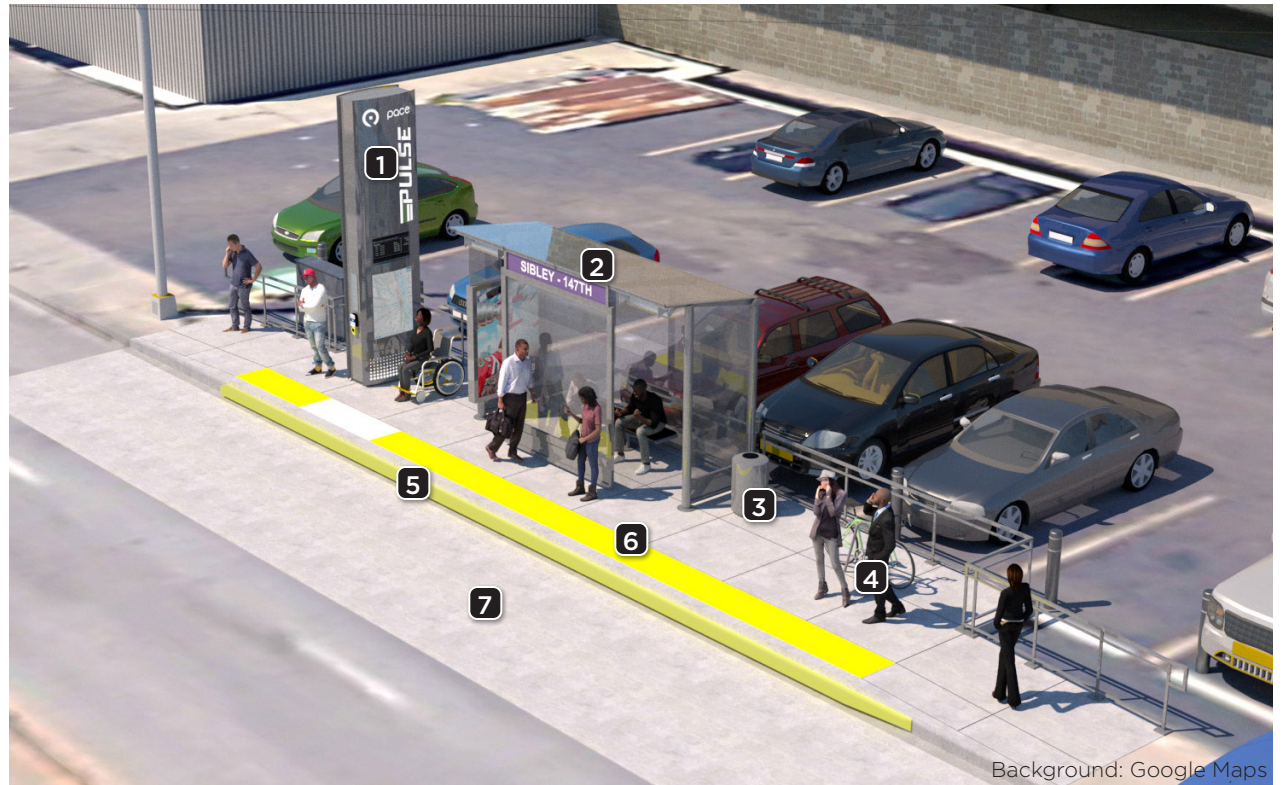

Background: Google Maps

- 1 Vertical marker with real time arrival display
- 2 Heated shelter with custom artwork
- 3 Customizable trash receptacle
- 4 Customizable bike rack
- 5 Bus curb
- 6 12-inch raised platform with heated pavement
- 7 Concrete bus pad

PREFERRED STATION PLACEMENT

Ideal Pulse station sites maximize safety and comfort while optimizing transit operations for schedule reliability. Safety and operational goals are affected by the presence or opportunity to add crosswalks, bus bulbs, continuous curbs, small turning radii, sight lines, pairing of stations, and pedestrian refuges. The placement of stations near or far side of signalized intersections and mid-block crossings are also factors in achieving safe and efficient operations.

CROSSWALKS

Stations should be near existing pedestrian crossing infrastructure for safe access to and from the bus station. Pace can coordinate with municipalities to make improvements where crosswalks and adjoining facilities such as curb cuts, curb ramps, and ADA access are in disrepair or non-existent.

Pace prefers to put stations near crossing infrastructure with a traffic signal and a protected pedestrian phase to maximize pedestrian crossing safety. Pace can assist with signal changes when they are associated with its Transit Signal Priority program.

BUS BULBS

Where there is available space in the right-of-way, Pulse stations can be built on bus bulbs, which extend curbs up to the travel lane. Bus bulbs allow the bus to serve stations without pulling in and out of traffic, enabling faster boarding and alighting of passengers. Bus bulbs also create greater station visibility and space for Pulse riders. When extended all the way to an intersection, bus bulbs can decrease the street crossing distance for pedestrians. Similar curb extension improvements may be implemented outside designated Pulse stations, such as across the street from a station.

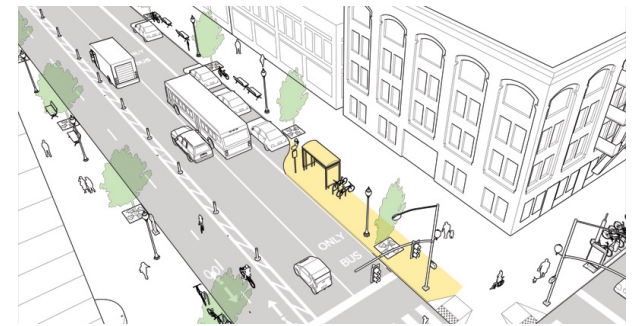

A bus bulb station

CURB CONTINUITY

Curb continuity is another safety benefit for pedestrians accessing Pulse stations. Where feasible, Pace will coordinate with municipalities and property owners to close underutilized driveways in order to remove conflict points between pedestrians accessing Pulse stations and vehicles turning in and out of driveways. This also allows more flexibility in the placement of Pulse stations further away from the intersection to preserve intersection sight lines. Typically, driveway closures are considered where driveways are very close to intersections and where there are other driveways that maintain vehicle circulation within the affected private property, or where the private property is no longer using the driveway as originally intended.

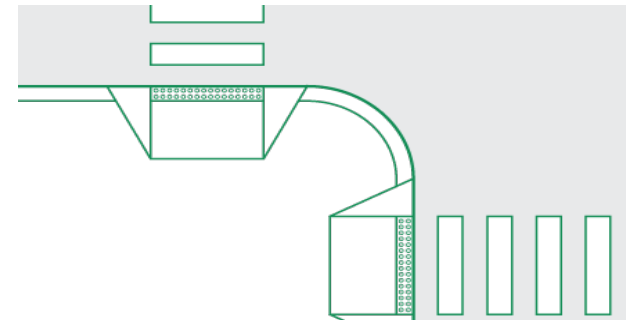

A small curb radius

Source: NACTO

TURNING RADII

Turning radii need to be considered at intersections serving Pulse stations to ensure pedestrian safety. Generally, application of the wheelbase 65 (WB65) standard, which is the turning radius for tractor trailers 65 feet in length, should be avoided where permissible to reduce the speed of turning vehicles through Pulse station intersections. The smaller the turning radius, the slower a vehicle will drive and the more likely the driver will see a pedestrian in an intersection.

SIGHTLINES

Stations should be placed far enough from intersections so that station amenities do not obstruct the clear view of oncoming traffic by turning and crossing vehicles. Additional sightline considerations include determining the impact of the station on nearby road signage, surrounding buildings, driveways, and alleyways, and adjusting the placement and design of the station as needed.

FAR SIDE OF SIGNALIZED INTERSECTIONS

Stations located before a traffic signal, or "near side," cause a bus to have an increased chance of stopping twice at an intersection: once at the station and again if the light changes to red while the bus is still loading passengers. When a station is located on the far side of an intersection, the

bus has an improved chance of having to stop only once. This would occur if the bus approaches the intersection on a green light, immediately passes through the intersection, and then stops to serve the station.

Far side stations also encourage passengers to cross behind the bus rather than in front of it, which is safer and beneficial to bus operations. Additionally, far side station placement is more compatible with transit signal priority technology, which is or will be installed on most Pulse corridors.

FAR SIDE OF MID-BLOCK CROSSWALKS

In urban settings with smaller blocks, regular street grids, and dense land uses, Pulse stations are typically located at signalized intersections where transit access is optimized by crossing infrastructure and transfers to other transit services. In suburban contexts, Pulse station locations are more likely to be sited by an activity generator such as a school, college, library, or government building that may be located in the middle of a block away from a signalized intersection. In this context, Pace will propose crossing infrastructure (if none already exist) near a Pulse station pair, and typically will site the stations on the far side of the crosswalk so that a pedestrian crosses behind a Pulse bus to avoid a potential bus-pedestrian conflict point.

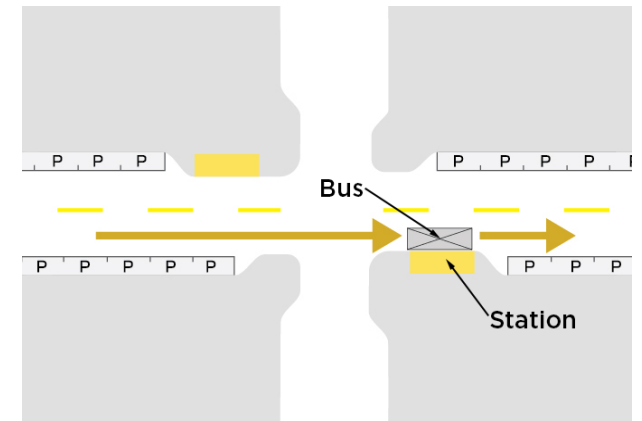

Far side station placement

Source: NACTO



Northbound Touhy Station on the Pulse Milwaukee Line
Photo by Andy Ryan

PREFERRED STATION PLACEMENT

COUPLING OF STATIONS

In general, riders board the bus on one side of the road to start their trip, and then alight on the opposite side after their return trip. Pulse stations are sited where station pairs can be located as close as possible to one another on opposite sides of a roadway. This helps with system legibility and avoids confusion by transit users that expect stations to come in pairs in close proximity to one another.



A Pulse station pair

PEDESTRIAN REFUGES

To improve safety, opportunities to implement pedestrian refuges across multi-lane roadways to connect pedestrians to Pulse stations need to be explored by Pace and the roadway jurisdiction. Where possible, pedestrian refuge islands should be 50 feet in length, with a minimum of 30 feet in length where space is constrained. Minimum lengths ensure safety through curb visibility and maximize distance between a pedestrian and vehicle. Furthermore, these islands must have a width of at least six feet, per the Illinois Department of Transportation. Incorporating an offset in the pedestrian island can further improve safety by forcing pedestrians to look toward oncoming traffic.



A pedestrian refuge island

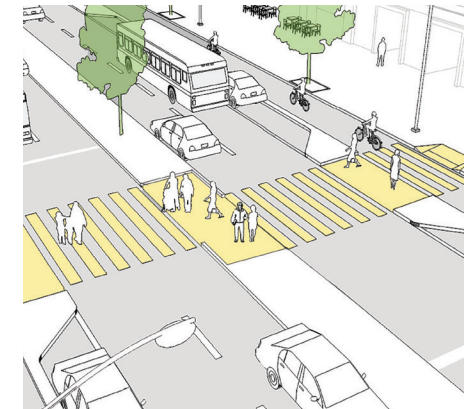

An offset pedestrian refuge island

Credits: photos located at the Devon Stations on the Pulse Milwaukee Line | by Andy Ryan
graphic by Global Designing Cities Initiative

STATION SIZES

Three typical station layouts, known as standard, length-constrained, and depth-constrained, have been developed to fit a station into a variety of constraints, such as the presence of driveways and other curb cuts, narrow sidewalks, building frontages, major utilities, trees, or retaining walls and grade changes.

The station dimensions and layouts shown on this page are the templates from which stations are designed. Each can be altered to fit the context of a unique site. For example, station dimensions may be "stretched" to avoid unusable space such as between the back side of a station and private building.

Where stations have significant bus traffic, such as at line termini and transfer points, or where the station is shared by other agencies, a station may be lengthened and contain multiple shelters and features. Stations can also be modified to fit an articulated bus, which is 60 feet long compared to a standard bus length of 40 feet.

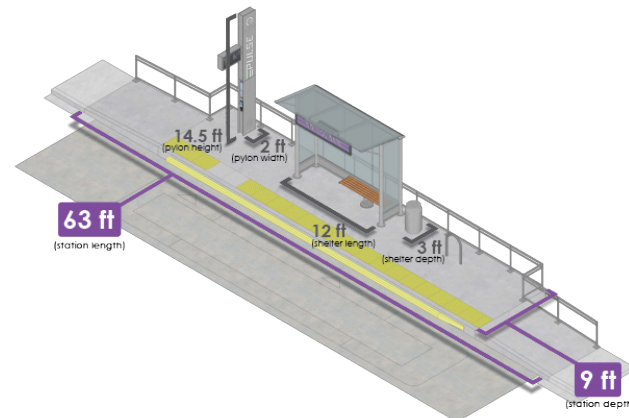
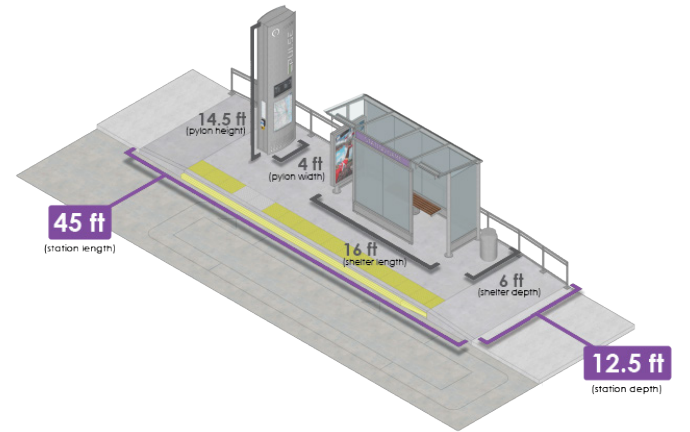
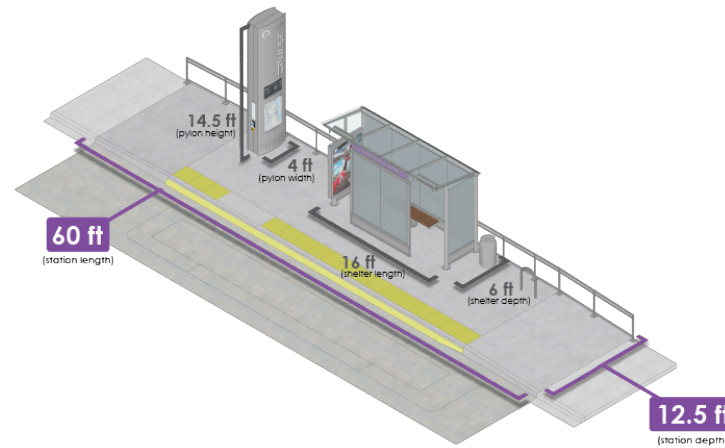

Standard

The standard station is the Pulse program preferred station layout that fits all amenities and ample space for passengers. Only when there is limited space in the right of way or other site constraints should the length-constrained and depth-constrained sizes be used.

Length-Constrained

The length-constrained station reduces the total length of the station (including ramps) from 60 to 45 feet through steeper ramps and removal of the bike rack. The depth is the same as the standard station design.

Depth-Constrained

The depth-constrained station reduces the station depth from 12.5 to 9 feet through a smaller shelter with no front wall panel and shallower side panels, as well as a smaller vertical marker pylon.

Layout	Minimum Dimensions	Features
Standard	60 ft long 12.5 ft deep	ADA-compliant ramps, shelter with front and back panels, bench, trash receptacle, vertical pylon (14.5' high by 4' wide), bike rack
Length-Constrained	45 ft long 12.5 ft deep	ADA-compliant ramps, shelter with front and back panels, bench, trash receptacle, vertical pylon (14.5' high by 4' wide)
Depth-Constrained	63 ft long 9 ft deep	ADA-compliant ramps, shelter with back panel, bench, trash receptacle, compact vertical pylon (14.5' high by 2' wide), bike rack

RIGHT-OF-WAY REQUIREMENTS

SIDEWALK/STATION CONFIGURATION

Pulse stations are designed for a variety of existing built environments to fit within available right-of-way and existing sidewalks and parkways. For example, stations can be designed with sidewalks running behind the station platform where space allows or integrated with the sidewalk, running through the station itself. When the sidewalk passes through the station, vertical components like the shelter and vertical marker are positioned to allow for a linear pathway for pedestrians. Regardless of layout, stations are designed to meet and, where possible, exceed minimum clearances to comply with the American with Disabilities Act (ADA).

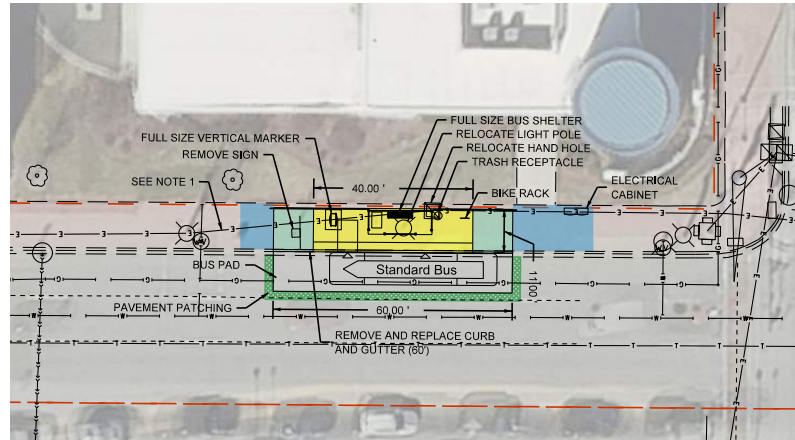

Proposed Pulse Station Design at W 95th St and S Western Ave

An example of a standard station integrated into the existing sidewalk with ample space for pedestrians to safely and comfortably walk through the station.

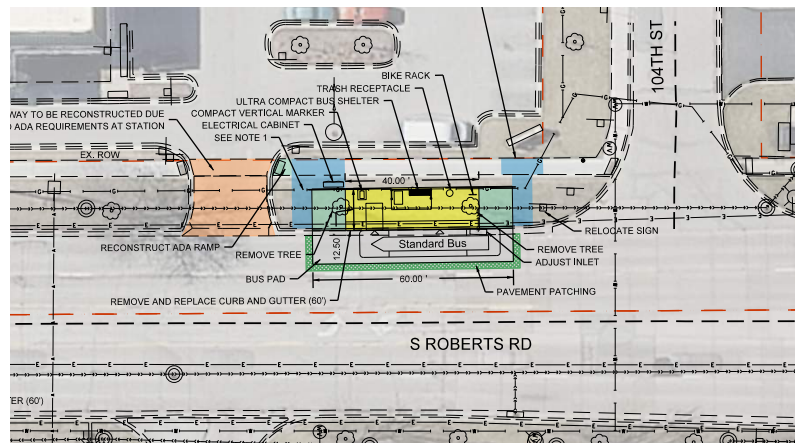

Proposed Pulse Station Design at S Roberts Rd and 104th St

An example of a station with a sidewalk behind it allowing pedestrians to walk behind the station instead of through it.

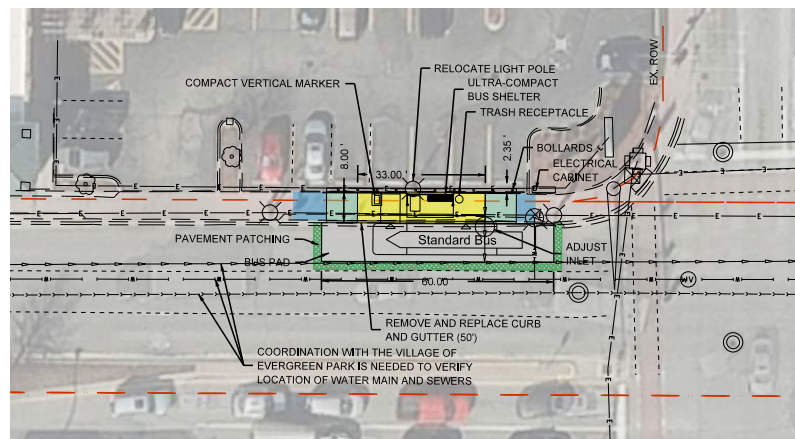

Proposed Pulse Station Design at W 95th St and S Kedzie Ave

An example of a depth-constrained station integrated with the existing sidewalk, which is narrow. While this design fits into a smaller area, it is still fully compliant with the ADA.

QUEUE JUMPS AND BUS LANES

Queue jumps are a lane design that helps give priority to buses at intersections. They function by allowing buses to skip from the back of a traffic queue to the front, improving timeliness and reliability. Queue jumps are made possible by a priority lane and special signal phase that allows the bus to “jump” the queue of general traffic at signalized intersections. The higher the traffic congestion is, the increasingly effective a queue jump can be.

Bus lanes are an additional bus priority strategy to improve bus speeds and schedule reliability. Bus lanes can be designed to be exclusive to bus traffic only. Another option, a business access and transit (BAT) lane, can be designed for general traffic to temporarily enter and/or cross bus lanes to make turning movements. Alternatively, some general traffic turning movements can be prohibited altogether. Bus lanes can be fully dedicated throughout the day or can be dedicated during peak travel times only.

The designs to accomplish any type of bus lane can include physical separation of bus and general traffic or delineation of lanes through a combination of pavement markings, tinted pavement, and signage.



Proposed queue jumps combined with far side, bus bulb Pulse stations.

Background: Google Maps



Proposed bus lanes on South Halsted Street in Chicago.

Background: Google Maps

POTENTIAL SOLUTIONS FOR BUS-BIKE INTERFACING

Many municipalities, counties, and roadway agencies across Pace's service area are investing in on-street bicycle infrastructure. This expansion results in an inevitable increase in interactions between bikes and buses. Design strategies that proactively consider these interactions can balance the demand for limited road space while prioritizing the safety of cyclists and bus riders.

There are a number of potential lane and station configurations that accommodate both bikes and buses. On streets with existing marked bike lanes, a common approach is to create a shared zone in front of the bus stop, where a bus must pull into the bike lane to align with the bus stop or station. A disadvantage of this design is the potential conflict point between bikes and buses sharing space, and it can also result in an undesirable "leap-frogging" pattern, where a bus and bike need to repeatedly pass one another as they progress through a corridor.

Optimal configurations reduce the conflict points between buses and bikes. A "floating bus stop" is placed between the bike lane and either the general traffic lane or the bus lane eliminating the need for buses to pull into the bike lane. Bus riders will cross the bike lane at designated crosswalks to reach the station.

Floating Pulse stations are likely feasible assuming that adequate space is available for minimum station amenities (shelter, pylon marker, and ADA accommodation). When roadway owners are considering installing bicycle infrastructure on designated future Pulse corridors, Pace encourages them to adequately size floating bus stops to accommodate future upgrades to Pulse stations (see Station Sizes section).

Additional design solutions may be recommended based on an individual corridor's design and context.

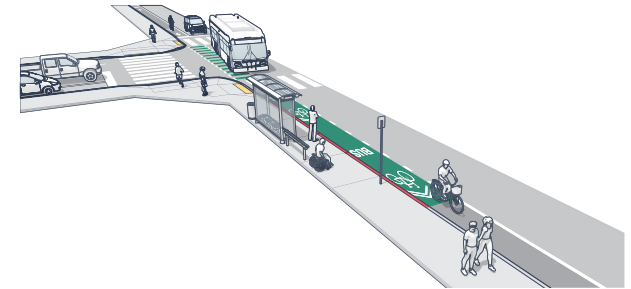

Marked bike lane between the curb and a general traffic lane

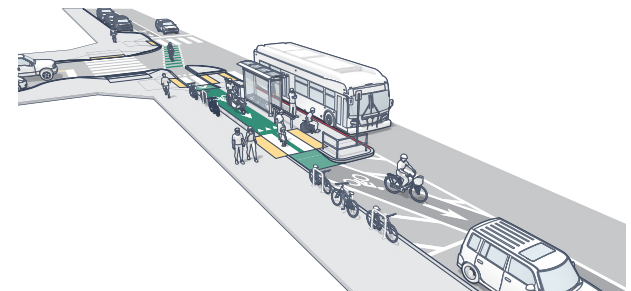

Floating bus stop with marked bike lane between curbside parking lane and general traffic lane

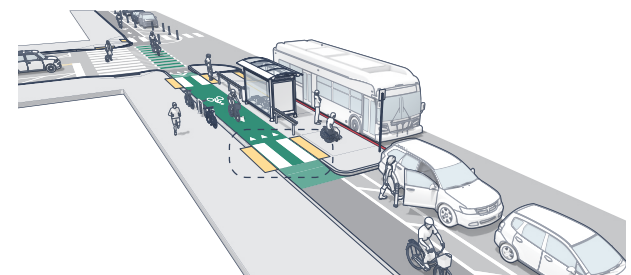

Floating bus stop with separated bikeway between the curb and parking lane

Source: AC Transit Multimodal Corridor Designs, 2018.

UTILITY WORK

Pulse station construction requires site excavation up to four feet deep to accommodate underground electrical and foundation work. Prior to site excavation, the availability of up-to-date municipal utility plans are essential to avoid conflicts. To the greatest extent possible, Pace will design around known existing utilities to reduce potential accidents and project delays.

Local jurisdictions can consider relocating utilities away from Pulse stations in advance during unrelated road work in order to avoid potential conflicts.



Station under construction on the Pulse Dempster Line | Photo by Andy Ryan

STREETSCAPE IMPROVEMENTS

Pace encourages local jurisdictions to coordinate right-of-way improvements such as resurfacing, painting, lane reconfiguration, or streetscaping in order to set the stage for Pulse improvements. This can include incorporating bus pads, curb extensions, pedestrian refuges, curb cuts, or other transit priority treatments such as queue jumps or dedicated lanes. When designing road improvements, communities should consider proposed stations sites and the approaching and existing bus movements when establishing street parking.

Where there is existing landscaping at a proposed station site, Pace will work with the property owner to incorporate landscaping into the station design. Wherever possible, Pace seeks to minimize impacts to existing landscaping, especially trees, and will make every effort to replace landscaping when it is impacted by the placement of a station.

SPACE FOR STATIONS

Typically, Pulse stations are constructed within the existing right-of-way for Pulse riders to easily access a Pulse vehicle and to avoid impacts to private property owners. However, right-of-way limits are often narrower than the space needed for a Pulse station. In those contexts, Pace will seek a permanent easement from the private property owner for the extents of a Pulse station.

Securing easements requires close coordination with property owners and can cause schedule delays if issues arise. To mitigate this risk, Pace seeks assistance through the following actions by jurisdictional partners:

- » Acquire right-of-way in advance where Pulse stations are planned, especially where right-of-way acquisition is already underway by the jurisdiction as part of other roadway improvements in the corridor.
- » Track and update contact information for property owners near Pulse stations.
- » When approving entitlements or development and incentive agreements, and when the project subject to approval contains or is adjacent to an existing or planned Pulse station, condition approval on accommodating the Pulse station.
- » When reviewing and approving subdivision, resubdivision, and consolidation plats for property adjoining current or future Pulse stations, ensure easement or dedication areas are included on plat for recording.
- » Coordinate with Pace once Pulse conceptual design plans are complete to understand the extent of easement needs and the benefit to residents for that Pulse station site. Additionally, jurisdiction staff and elected officials can assist Pace by expressing their support for Pulse and the benefits it brings to the community.

LOCAL PERMITTING, REVIEW, AND ADVERTISING REVENUE ARRANGEMENTS

Local jurisdictions have their own regulatory processes for the permitting of Pulse stations including number and type of permits, approving bodies, and application processes. Requirements may include right-of-way permits, building permits, design approval through bodies such as an appearance commission, and zoning variances. There may also be applicable restrictions such as sign codes or restrictions on advertising. Pace will benefit from learning in advance a jurisdiction's expectations for the permitting of Pulse stations and a staff contact to guide the permitting process from start to finish. Pace also encourages the jurisdiction to internally document all meetings, coordination and correspondence with Pace in the case of jurisdiction staff turnover during Pulse project final design and construction, which can span up to three years.

It is also recommended that local jurisdictions reach out to Pace before renewing contracts with providers of bus shelters or benches unaffiliated with Pace to ensure these programs do not prohibit Pace from constructing Pulse stations. For Pulse service, stations are maintained by Pace and its contractors, including trash removal, regular station cleanings, and other maintenance such as fixing vandalism or disrepair. For jurisdictions that permit off-premise signs, Pace also offers revenue-sharing options for advertising space in Pulse shelters through our Advertising Shelter Program.



Station under construction on the Pulse Dempster Line | Photo by Andy Ryan

SIGNAGE PLACEMENT AND DIMENSIONS

To achieve the ideal Pulse station placement, local jurisdictions should maximize design flexibility through their ordinances on private signage placement and size standards near Pulse intersections. Signage placement should avoid proximity to Pulse stations so that sight lines of signage are preserved from the right-of-way even when a Pulse station is constructed. To offer the most design flexibility for the siting of Pulse stations, private property signs should be set back from the right-of-way and intersections and should be taller than the standard Pulse shelter height of approximately ten feet.

These general guidelines are encouraged in addition to coordination with property owners and Pace when private developments with new signage are introduced for jurisdiction approval. This coordination should take place as early as possible given that a potential site for a transit station and signage placement is unique to each location. Coordination will ensure station siting proximate to signage maintains sign visibility distance minimums and associated safety standards for general traffic.



A Pulse vehicle on the Pulse Milwaukee Line | Photo by Andy Ryan

SAFETY

To maximize safety for Pulse riders, Pace recommends that municipalities install or upkeep lighting along Pulse corridors and intersecting transit routes. Pace similarly encourages the prioritization of Pulse station intersections for inclusion in any public camera programs.

Municipalities can also improve safety through design of the local environment. Pace encourages local planning, zoning, design review, and/or public works departments to consider transit supportive design in their review of development proposals along Pulse corridors and particularly within a mile of Pulse stations as presented in this Transit Supportive Guidelines document. Municipalities should use local authority to enforce pedestrian scale and street-facing development character for private sector development. Policies such as these can leverage Pace's investment in communities receiving Pulse service by creating the safe environment that attracts transit riders over the long term.



Northbound Devon Station on the Pulse Milwaukee Line | Photo by Andy Ryan

COMMUNITY EXPRESSION ELEMENTS

Pace coordinates with local communities to make Pulse stations easily identifiable and communicate the Pulse brand while incorporating local jurisdictional branding. Pace achieves this through customizable shelter panels, station furniture such as the bicycle rack, bench, and trash receptacle, railings, and landscaping.

SHELTER PANELS

Pulse station shelters will feature polycarbonate panels with a narrow mullion running between them. Customization will take the form of transparent film overlays. Pace will pay for the customized panels for the station shelters and will coordinate with communities on the design of the panel graphics. Pace will cover 100% of the cost of this custom element.

All station shelters can be customized. The following guidelines identify how Pace delegates customization opportunities for shelter panels:

- » If the station is in the public right-of-way, generally the first option goes to the municipality in which the station is located.
- » If the station is partially on private property, the municipality will still have the first option for customization in most cases. The exception to this is if the private property belongs to major institutional uses such as cemeteries, park districts, etc. that are unlikely to change in the near term, in which case Pace may recommend

that these entities be given the opportunity to customize the shelter panel design.

- » If entirely on private property, Pace will consider allowing private entities to customize the shelter panels on a case by case basis, depending on the type of use and likelihood that the use will remain unchanged for the life of the investment.

FURNITURE

Pulse stations include standard bicycle rack, bench, trash receptacle, and railing elements. However, municipalities may request a different alternative design to match existing streetscaping or other street furniture program.

If a municipality would like to substitute its locally preferred bicycle rack, bench, trash receptacle, and/or railing element, Pace will make the substitution provided that the cost is similar to or less than the elements selected by Pace. The municipality may also procure the substituted bicycle rack, bench, trash receptacle, and/or railing element that will be installed by Pace during station construction.

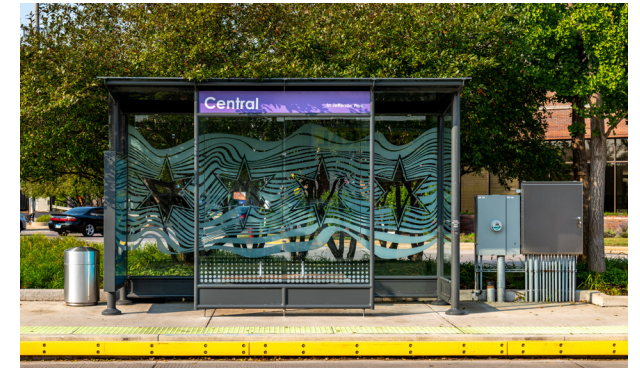

Above: Southbound Touhy Station on the Pulse Milwaukee Line
Below: Southbound Central Station on the Pulse Milwaukee Line
Photos by Andy Ryan

COMMUNITY EXPRESSION ELEMENTS

GENERAL PACE GUIDELINES FOR CUSTOMIZATION

A municipality may delegate customization decisions to local organizations. However, Pace accepts direction on station customization only from the municipal government (or county, or private property owner) in which the station is located and will enter into Intergovernmental Agreements only with municipal governments. If a municipality declines the opportunity to customize station features, Pace may opt to proceed with standard station features or custom features of its choosing. Pace has final authority to approve or disapprove all design treatments and customizations. Pace may opt to maintain design control over all features of the Pulse system and its stations, subject to compliance with local, state and federal regulations and permits.



Southbound Harlem Station on the Pulse Milwaukee Line
Photo by Andy Ryan